

MADE IN POLAND

MADE

vol. 1

VIKING KING

always with us

BACK TO JURASSIC PARK?

stones that tell a story

TOWARDS *THE SETTING* SUN

cowboy life in a saddle

VAGABONDS

then and now

Shinrin Yoku

user-friendly
wilderness

„EVERYONE DESERVES
WELL-DESIGNED
OBJECTS”

design that serves people



**WELCOME TO THE WORLD OF
GIFTS WITH CHARISMA!**

The objects we surround ourselves with set us apart from others. When chosen well, they give us satisfaction and are a manifestation of our personality and who we are.

We create things that are free from excess and exaggeration, beautiful in their simplicity, yet effective in their practical function.

Our products have a soul because each one is handmade and their unique character is a reflection of the artistry of our craftsmen and women.



Plaque with the emblem of the Guild of Various Trades.

CRAFTSMANSHIP & TECHNOLOGY

TECHNOLOGICAL SUPERPOWERS IN THE HANDS OF MASTERS OF THEIR CRAFT

Our company has its roots in the saddler's guild - we have been manufacturing leather goods for almost a century. The experience we have gained has allowed us to expand the range of materials we use in production, but natural leather is still the closest to our hearts.

Times change, new technologies improve the way we work, but in our company, real people are and always will be at the centre of things. We adapt technology to help craftsmen and women, not to replace them.



MADE IN EUROPE

POLISH PRODUCER, EUROPEAN STANDARDS

Production at our factory gives us direct control over the processes and the quality of the end product.

The majority of the leather we use is sourced from Polish tanneries, which we know well and visit to see with our own eyes how our future raw material is being made. Other certified materials are imported from the countries of European Union.



DESIGN LIKE NO OTHER

WE DO NOT PRODUCE COPIES OF COPIES

From the big picture to the detail - the concept comes first. Then comes the creative pool of the designing process. Our team of designers enables us to create outstanding designs from scratch and to improve them on the fly. Ideas spawn ideas, resulting in items that are different from what is already on the market.

Both smart solutions and the usage of materials have become our trademarks, which we are very proud of and excited about. Therefore many of our designs are registered and copyright-protected. This is how we guarantee to our customers that we offer authentic products - of our own design and manufacture.

Custom manufacturing is an important part of our business. Personalised products, tailored to the specific, individual needs of our customers, are unique by definition.

Wallets customised with the names of your team? Here you go. Easter kits for the fire brigade? No problem! Thinking of something we don't yet have in our product range? OK! Tell us what you need and we'll do the rest.

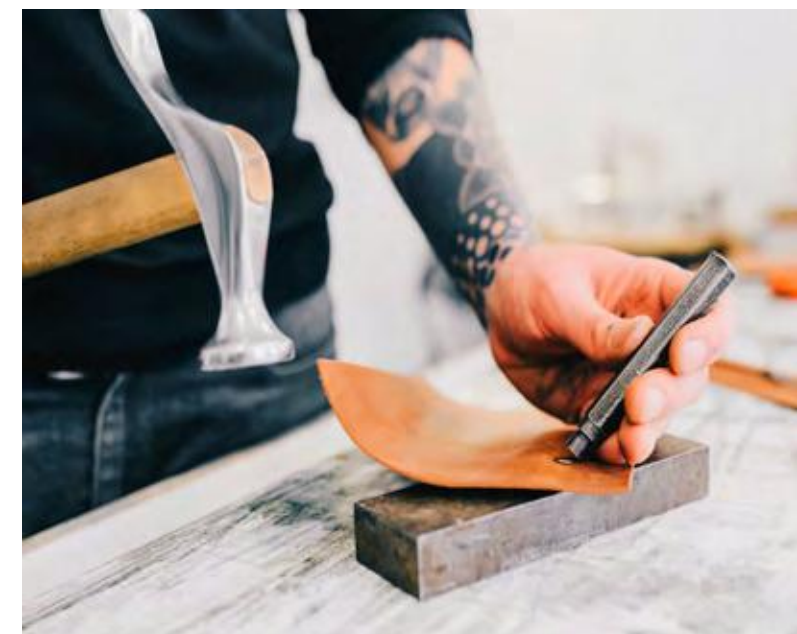

„Everyone deserves well-designed objects. Both a housewife and a millionaire”.

Philippe Starck



Monsieur Philippe Starck



Lemon squeezer JUICY SALIF by ALESSI. P. Starck

ERGONOMICS & ECOLOGY

Our project manager always says: „Form should be adapted to the function and every design element should make sense and make it easier for the user to use the object”. We couldn't agree more, which is why we place great emphasis on simplicity and the reduction of unnecessary bits. We also focus on minimising the use of materials, as it is important for us to design with respect for the environment and its natural resources.



SUSTAINABILITY

THE STATE OF THE ENVIRONMENT AND CLIMATE CHANGE ARE EXTREMELY IMPORTANT ISSUES. THEY CONCERN AND AFFECT US ALL.

A MEASURE OF MATURITY, EVEN FOR COMPANIES, IS RESPONSIBILITY - IN THIS CASE FOR DECISIONS MADE THROUGHOUT BOTH THE PRODUCTION AND POST-PRODUCTION PHASES. WE AIM TO USE RESOURCES SPARINGLY SO THAT THE NEXT GENERATION, WHICH WILL CONTINUE THE COMPANY'S DEVELOPMENT, WILL HAVE THE SAME OPPORTUNITIES FOR GROWTH AND LIFE IN A SHARED WORLD.



PEOPLE

Our business is seen as part of the local community. It is very important to us that we provide a fair, safe and respectful working environment, with opportunities for development for every employee. As an employer we are fully accountable - everyone we employ works in a modern factory that meets European standards. To help us make the right decisions in our day-to-day work, we have a Code of Conduct that sets out the ethical rules we have adopted for our company.

„It is not man who spins the fabric of life, he is but a small thread in it. Whatever one does to the fabric, one does to himself“.
Chief Si'ahl



ENERGY

Through the use of photovoltaic panels on the roofs of our buildings, we reduce the carbon footprint of our operations. Most of the energy we need to run our business comes from these panels, and we meet the rest of our needs by purchasing entirely renewable energy. As a result, we can proudly say that **the electricity we use is 100% green energy!** This reduces our dependence on fossil fuels such as coal and gas, which directly translates into lower carbon emissions.

RECYCLING

We are aware of the level of pollution on our planet, which is why we actively participate in recycling processes. The production waste we generate is sorted and sent to recyclers. To be even more involved in this process, we also source recycled materials such as paper, cardboard, leather or textiles, i.e. material made from PET plastic bottles or felt made from recycled polyester.



REACH

The products we offer meet the requirements of European Parliament and Council Directive 1907/2006/EC - REACH (Registration, Evaluation, Authorisation and Restriction of Chemicals). This means that our products are safe for the environment and meet the highest standards for toxic substances.

PACKAGING MANAGEMENT

„Disposable“ is synonymous with convenience and low price. However, these „disposable“ products and packaging live a very long life and their degradation process in the environment not only takes hundreds of years but also poisons the planet and all its inhabitants. It is a well-known fact that most products require packaging. Therefore, to reconcile the needs of the market and the environment, we choose biodegradable packaging (such as paper or wood) or packaging made from recyclable materials.



MATERIALS

WE CAREFULLY SELECT THE MATERIALS WE USE TO MAKE OUR GIFTS. IT IS IMPORTANT THAT THEY ARE BEAUTIFUL, DURABLE AND SUSTAINABLY PRODUCED.

PRIMAVERA LEATHER

PRIMAVERA leather, also known as a long-lived one, is a full-grain pull-up leather of the highest quality. It has been soaked with oil, thanks to which the wallet changes its appearance over time. It lightens in its folds and easily scratches, creating a natural vintage look. However, it is possible to restore its original appearance by polishing.

SADDLE LEATHER

The SADDLE leather is a material processed with plant-based tanning substances. For centuries it has been used to manufacture high-quality, comfortable saddles. It is tanned with vegetable substances and the hot wax in which it is soaked gives it its flexibility. Over time and due to usage, the leather changes - it gets scratched, its colour transforms in the folds, and a rich patina is developed. The SADDLE leather is appreciated for its raw beauty, durability, and versatility, and is used not only for saddles but also for a whole variety of leather products.

HUNTER LEATHER

HUNTER leather is a durable pull-up leather, commonly known as nubuck. Its surface has been polished, soaked in a special oil, and finally coated with a wax that allows the wallet to age beautifully, which creates a natural worn-out and second-hand look.

SPECTRO LEATHER

SPECTRO leather is a wholly ecological, soft-touch material made from a blend of recycled, bonded leather and rubber. This guarantees its complete resistance to water and dirt. Products made from SPECTRO leather will perform well in demanding conditions.

ITALIA LEATHER

ITALIA leather is a modern half-matte-finish leather, which is available in a wide range of vibrant colours. The surface of the leather has been sprayed with a colour aniline dye. Thanks to this the natural growth marks and the structure of the leather are preserved and still visible on the finished product. This is a unique feature of our natural, full-grain leather. Being a semi-veg-tanned leather, Italia leather is exceptionally soft and pleasant to the touch, yet strong and durable. In addition, the leather has been covered with a water-repellent varnish, which makes it dirt-resistant.

PU LEATHER

PU leather is a synthetic material made from biodegradable polyurethane. It most often reproduces the look of natural leather, being its cheaper alternative. However, its properties allow for a wider range of possibilities, as PU leather can resemble e.g. canvas, rubber, rusty sheet metal or even the surface of stone. It requires no special maintenance and is easy to clean.

BIRCH PLYWOOD

Birch plywood is a strong material made by glueing thin layers of wood together. It is easy to work with and allows a wide variety of designs to be created. Birch plywood has a naturally warm yet elegant appearance that can be enhanced by varnishing or staining.

FELT

Synthetic felt is a durable material made from recycled polyester fibres. It is lightweight, soft to the touch and gives a friendly feel to the products. Its flexibility and ease of moulding make it an extremely versatile material.

BAMBOO

For centuries, the natural elegance and durability of bamboo has fascinated people. Products made from bamboo are a blend of nature's harmony and functionality. It grows extremely fast, making it an easily renewable material. This allows for a responsible approach to production that celebrates nature's gifts while preserving the delicate balance of our environment.

WASH PAPER

Wash Paper is a modern, eco-friendly material widely used in the fashion and design world. It is a blend of cellulose and silicone that has a leather-like look and feel and exceptional durability. Wash Paper is washable, which makes it a great material to use for items that need to be maintained and cleaned regularly.

ACRYLATED CANVAS

Acrylated canvas is a durable and easy-care material made from acrylic-impregnated cotton fibres. A robust weight of 250g/m² combined with water-repellent properties ensures that products made from canvas will perform and last in the most demanding conditions.

ALUMINIUM

Aluminium alloy AW-6063 is a durable and lightweight material with high corrosion resistance and excellent extrudability, which means the ability to be formed into complex shapes. Aluminium is a fully recyclable material - it can be recycled over and over again without any loss in the quality of the raw material.

TYVEX

Tyvek is waterproof and lightweight. The polyethylene yarn from which it is made is abrasion and tear-resistant, ensuring the durability of products made from it, such as festival wristbands and numbers for marathon runners. Tyvek filters 99.9% of 0.5-0.7 micron particles while maintaining air permeability, making it widely used in the manufacture of laboratory clothing, for example. In addition, it can be recycled an unlimited number of times.



TO SEE THE WIDE RANGE OF MATERIALS AND GREAT PRODUCTS MADE FROM THEM, TAKE A LOOK AT OUR WEBSITE :)

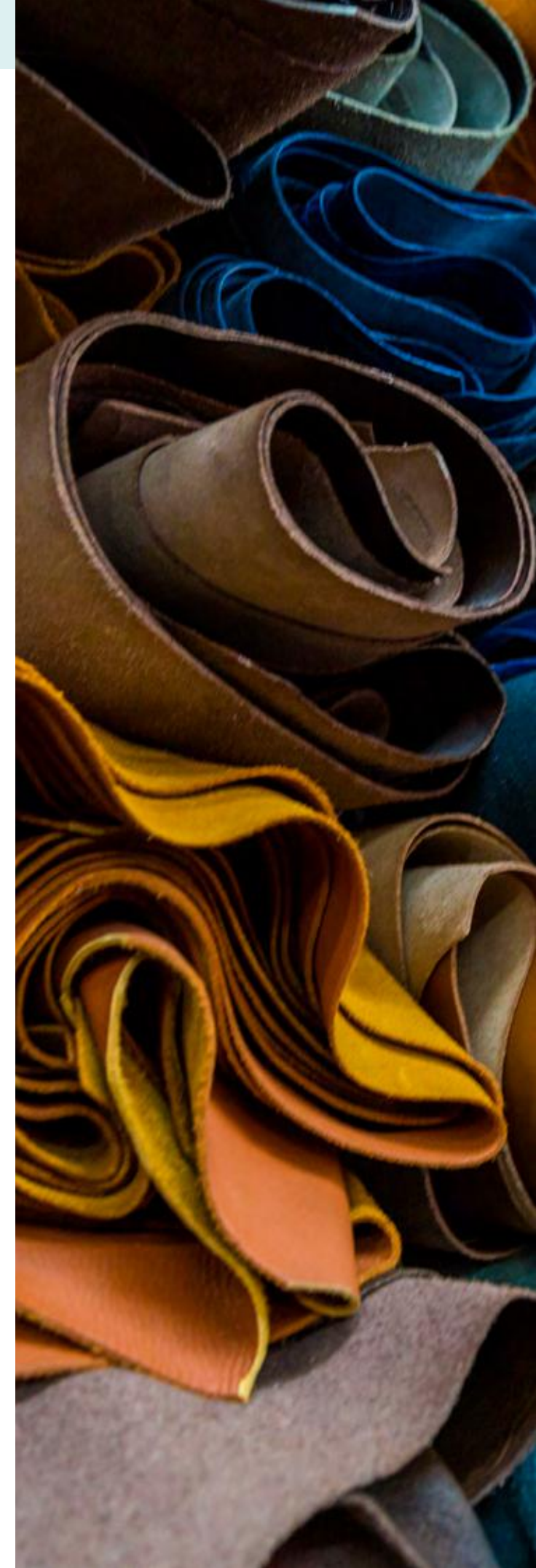



MARKING METHODS

ALL OUR PRODUCTS CAN BE DECORATED AND PERSONALISED. WITH YOUR LOGO, SLOGAN OR ANY GRAPHIC OF YOUR CHOICE. THE POSSIBILITIES ARE ENDLESS!



DEBOSSING

Leather debossing is a process that combines tradition, precision and craftsmanship. Brass matrices stamp the leather at a pressure of 100 kg/cm² and a temperature of 130-250 degrees Celsius, creating a three-dimensional effect in the form of a logo or decoration.



COLOUR FOIL HOT-STAMPING

Hot stamping uses thin, coloured foil. Pressure and heat melt the adhesive layer of the foil, which is then permanently applied to the surface of the material. This process can be repeated several times to create different coloured designs.



LASER ENGRAVING

Laser engraving is a modern technique (accurate to 0.01mm) used to decorate traditional materials such as wood, leather, felt or metal. A focused laser beam removes the top layer of the material to create a pattern, like text or graphics. It is a very precise method for the permanent decoration and personalisation of products.



UV PRINT

A technique for printing directly onto objects using ultraviolet light to cure the paint. This process ensures high quality and intensity of colours, as well as durability and abrasion resistance of the branding. UV printing is an excellent choice for frequently used products.



THERMAL TRANSFER

This process involves transferring colour graphics or text onto the surface of the product. First, a special printer prints the design onto a transfer film. The design is then applied to the target surface using a high temperature that affects the pigments on the film. This is a popular method that guarantees the durability and high quality of the coloured decoration.



NAME PERSONALISATION

Personalisation is done with brass fonts using high heat and pressure to emboss the text accurately and deeply. In case of thermal discolouring materials, the letters take on a contrasting darker shade, which improves their clarity and legibility.



ENGRAVED BADGE

Decorative panel, made of powder-coated aluminium or brushed stainless steel, with laser-engraved logo. Riveted.

MODIFICATIONS

MODIFICATION OPTIONS ARE AVAILABLE FOR MOST OF THE GIFTS WE OFFER. FIND OUT HOW YOU CAN TAKE THEM TO THE NEXT LEVEL!

UV PRINT

UV printing is highly durable and can be used on various materials. Because it can cover a large area, the possibilities go far beyond just a logo. It's also possible to create completely new, artistic, colourful materials.



GEMSTONES

Choose your favourite gemstone from our range and we will apply it to your chosen products for permanent decoration. Each stone is different and unique due to its natural origin and the character of the decoration is timeless. Elegant gemstones add a subtle and sophisticated touch to your gifts.



CALANDER

Calendering is the process of embossing a large area of material to give it a new texture or pattern. Any design - from a leather or wood pattern to something completely abstract - can be achieved with this method. It's also a great tool for designing your own elaborate materials based on repetitive logos or decorative elements. So why not feel like a famous designer? Products made from this material are sure to be unique.



CREATIVE STITCHING

This is a method in which a single stitch runs smoothly, looping and swirling to form a shape based on a single line. The variety of shapes that can be created is limited only by your imagination. Creative stitching can also be a distinctive addition to a debossed logo.



PACKAGING

A BOOK IS OFTEN JUDGED BY ITS COVER. THE FIRST IMPRESSION IS MADE ONLY ONCE. THAT IS WHY ATTRACTIVE PACKAGING IS SO IMPORTANT - IT IS WHERE THE CUSTOMER'S CONTACT WITH THE PRODUCT BEGINS.



FULL COLOUR BOX #978117

SIZE: 13 x 11 x 2,5 cm
 MATERIAL: PAPER 250g
 MINIMAL ORDER: 100 pcs/colour



FIRST IMPRESSION

Packaging is the first thing we look at, even before we open a gift. Aesthetically pleasing and well made, it is an expression of good taste and respect for the customer or recipient.

TAILOR-MADE PACKAGING

We make tailor-made paper packaging from scratch to suit your needs (and the products of your choice). We cut out and assemble the box. We also laser cut the foam filling for the product. An elegant ribbon to stabilise and decorate your product? Here you go.



BOX #984037

SIZE: 20 x 10,5 x 3,5 cm
 MATERIAL: COLOURED PAPER
 MINIMAL ORDER: 50 pcs/colour
 MARKING: colour foil hot-stamping, laser engraving, thermal transfer



Boxes can be made from your choice of colour-dyed paper, printed paper or kraft corrugated board. Packaging can be personalised by your logo - embossed with coloured foil or printed in full colour. The logo can be a stand-alone character or surrounded by other decorations.



*„Life is like a box of chocolates,
 you never know what
 you're going to get".
 Winston Groom, „Forrest Gump”*

HAVE A LOOK AT WHAT WE OFFER. TAKE YOUR PICK!



GIFT SETS

IF YOU CAN'T MAKE UP YOUR MIND, AND CHRISTMAS OR THE INTERNATIONAL WINTER BIKE TO WORK DAY (10 FEBRUARY) ARE JUST AROUND THE CORNER - WE'RE HERE FOR YOU.

SET UP YOUR SET-UP

There are times when it's worth going the extra mile. Gift sets are tailored to the occasion and their presentation alone is impressive. They may contain various or complementary products (as in an office or travel set). But if you dream of a completely different, personalised set, we can make one just for you.

MORE THAN SPECIAL

Everything happens right here in our factory. The selected products are assembled and the next step is to design the gift packaging. (You can read more about packaging on page 12). We produce all the elements - the box and its laser-cut foam filling - to protect and stabilise the gifts.

Both the packaging and the products in the set can be personalised with your logo or decorated to suit the occasion (see „Marking“ on page 8 and „Modifications“ - page 10). We pack the sets by hand with the utmost care and attention to detail, to make your special set even more special.

„The art of giving a gift is to offer something that cannot be bought in any shop“.
A.A. Milne, „Winnie the Pooh“



1961327
GIFT SET WITH KEYRING



1331036
GIFT SET WITH AMBER



REAL
 BALTIC
 AMBER!



1711076
OFFICE GIFT SET



2108141
RFID WALLET GIFT SET



SCAN THE QR CODE AND CHOOSE YOUR OWN SET.
 OR DO YOU HAVE A DIFFERENT IDEA?
 NO PROBLEM :)



AVAILABLE IN MANY COLOURS! FOR EXAMPLE



BLACK BROWN BLUE RED YELLOW

RFID WALLET #1225131

THE COTTAGES DOTTED ALONG THE ITALIAN COAST - GLISTENING IN THE SUN AND BURSTING WITH BRIGHT COLOURS - INSPIRED US TO CREATE THIS COLLECTION.

SIZE: 7,5 x 9,5 x 2,5 cm

MATERIAL: ITALIA LEATHER

MINIMAL ORDER: 50 pcs/colour

MARKING: debossing, colour foil hot-stamping, laser engraving, UV print

- ✓ banknote pocket
- ✓ space for 9 cards
- ✓ RFID protection
- ✓ paper box



OTHER MODELS IN COLOURED ITALIA LEATHER



1237131 618131 1226131 545131 384131



Painted in bright colours, the small houses of the Italian coast had, apart from their undoubted decorative qualities, another important function. Visible even in the dim light of dawn or in the fog, they served as a guide for fishermen returning home from their morning catch. But the colourful buildings did not only serve the fishermen of Italy...

WINDOW TAX

The Ligurian region of Italy is famous for the paintings on its villas, and it all began in the 15th century in Genoa. The new Renaissance fashion resulted in the construction of many palaces and townhouses, which were extremely rich decorated with sculptures, stucco and many windows with decorative shutters. Not everyone could afford to live in such beautiful houses, so

less wealthy property owners, who wanted to be in fashion, had to think of something different. This is how the new and lucrative profession of the house facade painter was born. These painters sometimes reached artistic heights by painting decorations, cornices and sculptures on bare walls. The decorations were almost three-dimensional and gave the impression of real ornamentation. To save even more money, the owners of the townhouses did not have many windows in the front. They placed most of them in the courtyard. The reason for this was that the former were heavily taxed. And this is where the painters came to the rescue. They just painted... windows - closed, ajar, sometimes with a figure „looking out“ onto the street. Genoa is still extremely, nomen est omen, picturesque and has been included (along with many other colourful Italian towns) on the UNESCO list of World Heritage Sites.



RFID WALLET #545141

THIS IS A WALLET MADE FROM THE FINEST LEATHER WHICH HAS BEEN TREATED WITH NATURAL OIL.

Full-grain leather, similarly to human epidermis, responds well to care. Natural oils can be used to prevent the development of patina. The best oils for a nourishing oil treatment of the leather are sunflower oil, linseed oil or the unassumed hero - rapeseed oil. What about olive oil?

LIKE A NOBLE DRINK

Olive oil is not the best leather conditioner - it darkens it. Olive oil is best consumed, especially in its richest form - extra virgin olive oil (EVOO). It is rich in flavour, aroma and omega-6 and omega-3 fatty acids, which support the circulatory system, nervous system, vision and also delay the ageing process. It is rich in anti-carcinogenic antioxidants such as polyphenols. (If your oil tastes bitter and gives you a slight scratch on the throat - all the better. It means it really does contain a lot of polyphenols). At the top of the olive hierarchy is EVOO Monovarietal. Like whisky, it is sometimes called 'single malt'. It is pressed from olives of a single variety, sometimes from a



SIZE: 7 x 10 x 2 cm
MATERIAL: PRIMAVERA LEATHER
MINIMALNE ZAMÓWIENIE: 50 pcs/colour
MARKING: debossing, colour foil hot-stamping, laser engraving, UV print

- ✓ banknote pocket
- ✓ space for 6-7 cards
- ✓ RFID protection
- ✓ paper box

*„Price is what you pay.
 Value is what you get”
 Warren Buffet*



single olive grove, and no oil of any other origin is added. Studies confirm that oil pressed from a single variety, processed locally and not oxidised during the blending process, is the highest quality oil in terms of both health and sensory qualities. Local production also reduces the carbon footprint and contributes to the preservation of ancient olive groves in Mediterranean countries.

THE OIL OF THE NORTH

Speaking of local production, just north of the Mediterranean, a golden oil is also pressed. Its source is the rapeseed, which cheerfully blooms in vast yellow fields. Cold-pressed and unrefined, it is gold in a bottle! It surpasses its southern cousin in terms of health properties. Going back to the essential omega-3 fatty acids, their total content is around 1% in olive oil, compared to 10% in unrefined rapeseed oil. Not only is this the highest content of these acids among the vegetable fats available, but rapeseed oil is also the only one in which omega-6 and omega-3 are present in the ideal for human health 2 to 1 ratio (which is very important, as an excess of omega-6 has a pro-inflammatory effect). Although it does not contain polyphenols, it makes up for this by containing ADEK vitamins, which also have anti-cancer properties.

So let's take a kinder look at this gold-hearted hero in a bottle!



**MORE PRODUCTS
 MADE OF THE OILED
 PRIMAVERA LEATHER**

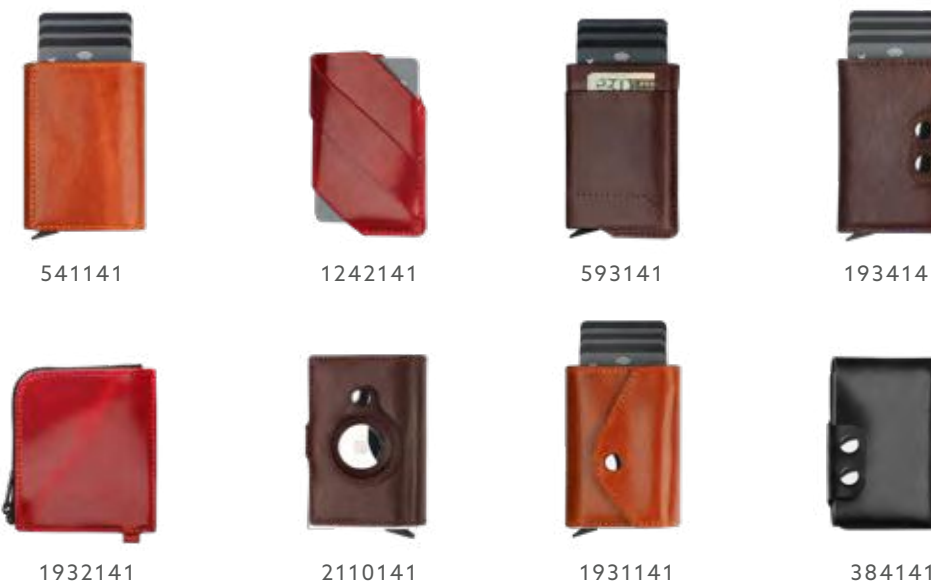

RFID WALLET #618329

WE LOVE NATURAL LEATHER, BUT WE VALUE PU LEATHERS JUST AS MUCH - FOR THE WIDE RANGE OF POSSIBILITIES THEY PROVIDE US WITH. ANYONE FOR A STONE WALLET?

VEGAN VERSION

Behold our minimalist RFID-protected wallets in a vegan version. Made from PU leather, they are an alternative to those made from leather of animal origin.

BRICKS AND STONES

The most common synthetic leather we use imitates the colour and texture of natural leather. This is not the only option available though. Also other textures and colours are available, often not so obvious. This allows us to create wallets with a varied and interesting look. How about a durable wallet that looks like it's made of stone? Or one that looks like it has been stitched from canvas? Or how about a loft-style wallet that looks like it's covered in rust? Modern PU leather really does offer many interesting and inspiring possibilities!

MONEY BEFORE MONEY

What we carry in our wallets today results from a long evolution in payment methods. Back in the day, things were a little different. In ancient China, for example, it was common to use tea leaves compressed into bricks for easy carrying and storage. Cowrie shells, now mostly a summer decoration, were used to pay for goods, especially in Asia and Africa. In ancient Rome, soldiers were sometimes paid in salt, hence the word „salary“. But nothing beats the former currency of the Micronesian islands. People there used to use stone discs called Rai. They were huge, weighed tons and were transported by canoe. The larger, rounder and more difficult to transport, the more valuable they were. Phew! Let's better stick to banknotes and coins...



SIZE: 7,5 x 9,5 x 2,5 cm
MATERIAL: LANCASTER PU LEATHER
MINIMAL ORDER: 50 pcs/colour
MARKING: debossing, colour foil hot-stamping, laser engraving, UV print

- ✓ banknote pocket
- ✓ space for 9 cards
- ✓ RFID protection
- ✓ paper box

STRAIGHT FROM THE HANDS OF MRS HELENA!



618321



1249326



1226324



1282327



1237325



593321

SCAN TO SEE MORE WALLETS IN A VARIETY OF PU LEATHER FINISHES!





RFID WALLET #2109284

„GOOD DESIGN IS AS LITTLE DESIGN AS POSSIBLE.... A RETURN TO SIMPLICITY“, WROTE DIETER RAMS. THIS IS HOW WE DESIGN OUR WALLETS, IN THE SPIRIT OF MINIMALISM.

SIZE: 7 x 10 x 2,5 cm

MATERIAL: HUNTER LEATHER

MINIMAL ORDER: 50 pcs/colour

MARKING: debossing, UV print

- ✓ banknote pocket
- ✓ space for 8 cards
- ✓ RFID protection
- ✓ paper box



BLACK



BROWN



CHERRY



COGNAC



OLIVE



NAVY BLUE

A PLEASING SIMPLICITY

Minimalism is a design style characterised by extreme spareness of means and simplicity. Often described as the most enduring design trend, minimalism affects not only personal style but also quality of life. When faced with complexity and excess, our brains find the situation overwhelming. (Who hasn't sighed at an overly long menu in a restaurant?). Simplification removes distractions and allows the user to focus on what's the most important. A number of studies have shown that there is a link between the voluntary choice of simplicity and minimalism and improved well-being.

MORE MODELS MADE OF HUNTER LEATHER!



593284



1931284

RAMS' RULES

German industrial designer Dieter Rams, born in Wiesbaden in 1932, is one of the most important designers of the 20th century. Award-winning and globally admired, he is the author of many product designs for brands such as Braun and the iconic furniture manufacturer Vitsoe. As early as in the 1970s, Rams was an advocate of sustainability, designing minimalist objects that did not require the over-exploitation of natural resources. His influence on the design world is still evident today. Echoes of Rams' famous universal shelving system can be seen in IKEA's customisable furniture systems. Apple founder Steve Jobs spoke openly about his fascination with Rams' designs for Braun (including speakers, radios and calculators). These designs were, and still are, the roadmap for designers working on Apple devices.

1958



2001



Dieter Rams is an author of a book that has become one of the bibles of design. The „Ten Rules of Design“ aptly defines the role of projects and the designer in the modern world. We invite you to read a summary of these principles in the box below and are proud to say that we follow each and every one of them when designing our wallets.

TEN RULES OF DESIGN

1. Good design is innovative. Familiar solutions can often be improved.
2. Good design is useful. It performs exactly the functions it is expected to.
3. Good design is aesthetically pleasing. It brings joy to the user through its look.
4. Good design is discreet. An industrial product should not be a work of art, but a tool in the hands of users, giving them space to express themselves.
5. Good design is easy to understand. The user intuitively knows how to use it.
6. Good design is honest. It does not pretend to be what it is not. It does not deceive.
7. Good design is long-lasting and timeless. It does not succumb to trends and fashions, so it can remain relevant for a long time. In fact, it is impossible to create a completely timeless design - we have to expect it to be modified and improved.
8. Good design is refined. Planned and produced with attention to the smallest detail. Every element should be thoughtful and purposeful.
9. Good design is environmentally friendly/neutral through the use of appropriate, sustainable, non-harmful materials.
10. Good design requires as little design as possible. Less, but better.



Herr Dieter Rams

RFID WALLET #1931310

WHEN YOU TAKE THIS WALLET OUT OF YOUR POCKET AND LOOK AT IT IN YOUR HAND, IT MAKES YOU WONDER WHERE YOU PARKED YOUR HORSE...

Ready for a wild ride? Then put your hat on and let's talk about one of our strongest materials - SADDLE leather.

LEATHER MADE TO LAST

This beautiful material has been used for centuries in the manufacturing of top-quality saddlery. Made to last, a classic cowhide! It is tanned using vegetable tannins, which gives it its characteristic earthy, musky scent. During the manufacturing process, hot wax is used to penetrate the structure of the leather, giving it flexibility and water resistance.



It is therefore slightly thicker than other types of leather. Over time and with use, SADDLE will become scratched, its colour will change in the folds and it will take on a fine, natural patina. The longer it is used, the softer and more durable it becomes, which translates into comfort for the user. This is why cowboys treasured their saddles, which served them reliably for many years.

WHEN THE COWBOY'S WORK IS DONE

Today we can only imagine what a relief it must have been for someone who had spent weeks in the saddle on a cattle drive. One can also imagine how wonderful it was to finally reach the destination town, park the horse and walk into the local saloon. To shake off the thick layer of dust and order a beer with a free meal (common saloon marketing). To catch up with the comrades, look strangers in the eye, dance with beautiful damsels, play poker and sing over the last glass of whisky. Maybe have a bit of a brawl (verbal, of course), then finally fall asleep - in bed and peace at last.

Sleep tight, cowboy. When the morning comes, you'll be back on horseback, ready to hit the road for the long journey home...



SIZE: 6,5 x 10 x 2,5 cm

MATERIAL: SADDLE LEATHER

MINIMAL ORDER: 50 pcs/colour

MARKING: debossing, laser engraving, UV print

- ✓ banknote pocket
- ✓ space for 7 cards
- ✓ coin pocket
- ✓ RFID protection
- ✓ paper box

„No hour of life has been wasted when it has been spent in the saddle“.
Winston Churchill

CHECK OUT WHAT ELSE COWBOYS ARE UP TO!



TOWARDS THE SETTING SUN

Working with SADDLE leather is a great pleasure for us. It is possible to sew many copies of a given model from it and each one will look slightly different. Due to the extraordinary touch sensitivity of the material, the use of the wallet results in frequent changes in the pattern on the leather, which is simply spectacular and must be seen with your own eyes. The wallet looks and smells wild and raw, but it's a solid companion (even on a journey towards the setting sun). Well worth capturing and taming!



384310



541310



2109310



1935310

WALLET #369084

ONCE UPON A TIME, BOTH WOMEN AND MEN WORE BAGS AND POUCHES ATTACHED TO THEIR WAISTS. WHY DO WOMEN TODAY CARRY HANDBAGS AND MEN RATHER NOT?

SIZE: 11,5 x 20,5 cm
MATERIAL: GAIA PU LEATHER
MINIMAL ORDER: 1 pc/colour
MARKING: debossing, laser engraving

- ✓ 2 banknote pockets
- ✓ 2 compartments for documents
- ✓ 2 zipped pockets
- ✓ 2 credit cards pockets
- ✓ zipped internal coin compartment
- ✓ paper box

WHAT TO DO WITH THE HANDS?

Bags and pouches, worn at the waist in the Middle Ages, gradually were moved under the top layers of clothing to protect them from theft. As the centuries passed and fashions changed, pouches hidden in the folds of clothing became an integral part of ... men's outfits - as pockets. As the more mobile part of society, men sometimes had many of them - varying in depth and size to accommodate different types of content. Women had to cope differently as their outfits, both formal and casual, had no or very few pockets (sometimes purely decorative). In the 18th century, the small handbag called a reticule appeared, the great-grandmother of all handbags as we know them. It was a response to the Empire style of dress which was in fashion that time. It was narrow, close to the body and unable to hide anything in its folds. The reticule became indispensable for two important reasons - it stored essential items when a lady left the house, and it answered the ageless human need to „do something with your hands“. It wasn't until the 1920s, when women liberated themselves from corsets, that dresses with large pockets began to appear. Satisfied ladies could finally walk around with their hands in their pockets, but that's another story...



TOGETHER FOREVER

Handbags have stayed with us for good and are certainly no longer a symbol of lack. On the contrary. They are desirable and fashionable accessories, and some of them can cost a fortune. Still, they are practical and useful.

Is our big wallet with a handle already a handbag? We think it is. It's big enough to hold a lot more than money and documents. A few plasters - just in case. A flyer for the local pizzeria, earrings, a letterbox key, and those twelve receipts that are better kept for a while.

WORLD'S MOST EXPENSIVE EASTER EGG

The world's most expensive handbag is made from an emu egg, decorated with blue diamond dust enamel, 8,000 diamonds set in platinum and 24-carat gold, and a pair of Cartier earrings used as a clasp. It belongs to a woman who wanted to give some of her valuables a second life on the occasion of Easter holidays. The inside of the bag is lined with an iconic Hermes scarf, and the whole thing cost the owner \$6.7 million. The designer is Debbie Wingham. She specialises in creating „the world's most expensive items“ for billionaires, especially those in Dubai.



Reticule handbag, a sketch.



TAKE A LOOK AT OTHER WALLETS THAT HOLD A LOT!



363083



360082

RFID WALLET #300013

A WALLET WITH A FAMILIAR SILHOUETTE, ONE OF THE MOST POPULAR GIFTS. IT IS A WELL-KNOWN CUSTOM TO PUT A PENNY FOR GOOD LUCK IN A WALLET THAT IS GIVEN TO SOMEONE AS A GIFT.

SIZE: 10 x 12,5 cm

MATERIAL: CLASSIC LEATHER

MINIMAL ORDER: 1 pc/colour

MARKING: debossing, colour foil hot-stamping, laser engraving

- ✓ 2 banknote pockets
- ✓ 2 transparent pockets
- ✓ 5 compartments for documents
- ✓ 6 credit cards pockets
- ✓ coin pocket
- ✓ RFID protection
- ✓ wooden box

FOR A GOOD LUCK

There is a superstition that more money will be „attracted“ to the recipient if they are given a wallet with pennies or other amulets in it. In Chinese tradition, it's three coins with a square hole connected by a red thread. In some European countries, including Poland, such a talisman is a carp scale left over from Christmas Eve dinner. The Irish might put a clover in such a purse - but a five-leafed one. According to ancient belief, it is the five-leaf clover that brings wealth to its owner.

If you break the mirror with your reflection in it, it will affect your fate badly for seven years. Whatever happens to the voodoo doll will also happen to the person it represents. It is better not to step on a cracked surface because it will „crack“ something in your life.

WELCOME TO THE SUPERSTITIONS MINI-GUIDE!



358013



308013



356013



357013



330013



319013



BLACK CAT (European origin)

Although cats were often associated with good luck and were even worshipped as gods in ancient Egypt, things took a bad turn for our dark-coloured furries in the 13th century. It was then that Pope Gregory IX issued a bull declaring them to be „the incarnation of Satan“. From then on, black cats found themselves in an unglamorous position, burned in bonfires on holy days such as Carnival, Lent and Easter. They also became a symbol of black magic, an attribute of witches, and a harbinger of inevitable misfortune.

TO KNOCK ON WOOD (Indo-European and Celtic origin)

Have you ever tried knocking on wood to ward off evil? This superstition derives from the ancient pagan belief that good spirits lived in trees and could be summoned to help by knocking on their house. Knocking also prevented evil spirits from hearing a person's speech and causing them harm. Depending on the region, this superstition can slightly vary, e.g. in Poland, it is unpainted wood, in Turkey it is knocking twice, and in Latin America, it is knocking on wood that has no legs (not a table, a chair, etc.).

TO THROW SALT OVER ONE'S LEFT SHOULDER

(ancient and Judeo-Christian origin)

This is another way of warding off evil. Since ancient times, the human imagination has personified the right side as just... right, good. Similarly, evil attacked from the inferior left side. This is where bad impulses, wrong decisions and misfortune come from. For centuries, salt has been a difficult to obtain and therefore expensive resource. Making a certain sacrifice by throwing it over one's left shoulder was supposed to prevent greater harm than the loss of a handful of precious spice.



FOUR-LEAF CLOVER (Celtic origin)

The Celts believed that the four-leaf clover had magical powers and protected against bad luck and evil. It was also believed that carrying it with you would allow you to see the fairies. Celtic fairies were dangerous little creatures who could play deadly tricks or steal children, so being able to see them offered a chance to avoid misfortune. However, finding a four-leaf clover is not so easy, as scientists have (naturally) confirmed. According to a study conducted in Switzerland, the odds are 1 in 5,000. Good luck!



TAKE A LOOK AT OTHER WALLETS WITH RFID PROTECTION!



RFID CREDIT CARD HOLDER
SAND FINISH #944108

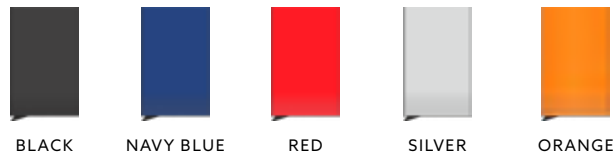

SIZE: 6 x 9,5 x 1 cm
MATERIAL: ALUMINIUM
MINIMAL ORDER: 1 pc/colour
MARKING: laser engraving, UV print

- ✓ space for 6-7 cards
- ✓ RFID protection
- ✓ TÜV quality certificate
- ✓ paper box

RFID TECHNOLOGY

It sounds complicated, but everyone has experienced it at one time or another - paying with a card in a shop, using a monthly travel pass in the form of a plastic card, or opening the door to a garage or house with a key fob.

WHAT IS THIS ABOUT?

The RFID (Radio Frequency Identification) system, in a nutshell, is a technology based on a transmitter containing digital data (RFID tag) and a receiver that reads and records this data at a distance. The RFID tag has a chip and an antenna, which uses the energy of the radio wave from the RFID reader. In this configuration, the tag receives the signal from the reader and sends back the information stored in the chip.

RFID systems can be divided into three types based on read range, which depends on radio frequency.



RFID CREDIT CARD HOLDER
BRUSHED FINISH #944155



- **LF (Low Frequency).** This system operates in the 30 kHz to 300 kHz range. It has a short read range of 10 cm and slower reading speeds. It is used for animal chips, access cards or payment cards.
- **HF (High Frequency).** It operates at frequencies from 3 to 30 MHz, with reading ranges from 10 cm to 1 m (e.g. NFC for contactless payment with a smartphone).
- **UHF (Ultra-High Frequency).** This system operates at frequencies from 300 MHz to 3 GHz, with a maximum reading range of 12 m. It is used in anti-theft alarm systems.

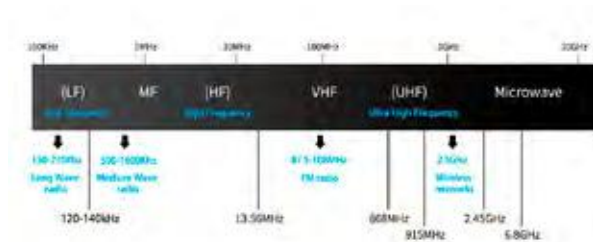

In case of payment cards, RFID technology enables fast and convenient contactless payments. But it also creates the threat of potential theft. In practice, all a thief needs is a smartphone with a scanning app installed, and anyone within range is at risk. On the tram, in the checkout queue in a shop, in a restaurant - anywhere.

TAMING THE WAVES

Michael Faraday discovered in the 19th century that an object made of conductive material and hollow inside prevents electric and electromagnetic fields from entering it. Our aluminium case works on this principle. The waves are neutralised and RFID card tags are unable to make any contact with them. Payment cards are therefore protected and secure, which we regularly check and test ourselves. We have also tested the gradual card ejection mechanism, so we know that **the card ejection lever still works perfectly after 100,000 pulls**. We have gone to great lengths to ensure that the internal components of the case prevent cards from falling out unintentionally, while still allowing them to be ejected smoothly when required.

MORE THAN JUST A CASE

And now for something really special! Our case can hold more than just payment cards! Order an additional pocket made of rigid plastic (**product #208212301**) to enrich the case with space for a pair of banknotes. Because even the most dedicated fan of wireless payments will sometimes make a spontaneous decision at the flea market. And what if the power goes out somewhere?

And if you are the one who easily loses things, we highly recommend the AirTag holder (**product #2096123**). Place your case in its firm grip and keep everything under control!

*holder does not include AirTag

RFID PASSPORT CASE #1301113

DID YOU KNOW THAT YOU NEED TO BE VACCINATED AGAINST YELLOW FEVER, TETANUS, DIPHTHERIA AND WHOOPING COUGH, POLIO, HEPATITIS A AND B, TYPHOID, RABIES AND MALARIA BEFORE EMBARKING ON YOUR DREAM TRIP THROUGH AFRICA?

SIZE: 10 x 14 cm

MATERIAL: SAFFIANO PU LEATHER

MINIMAL ORDER: 50 pcs/colour

MARKING: debossing, colour foil hot-stamping, laser engraving, UV print

- ✓ 3 compartments for documents
- ✓ 4 credit card pockets
- ✓ passport compartment
- ✓ RFID protection



COLLECTING PLACES

Many travellers like to „collect“ passport stamps from places they visit. They form online communities that brag about what they’ve collected and cheer each other on as they travel. Some are envied by others for having collected stamps that are particularly difficult to obtain. These include the Easter Islands, where only one plane a day lands from Chile’s capital, Santiago. Then there is Bhutan, the airport of which is in the Himalayas and landing is so difficult that only a few pilots in the world are qualified. Or the world’s most isolated volcanic island, Tristan da Cunha, which can take up to 10 days to reach from the South African coast. And finally, the Marshall Islands, which could soon disappear underwater due to rising sea levels caused by climate change.



KEEP IT SAFE WITH ME!

GET THE YELLOW BOOK & CARRY ON

To make sure that everything is well documented and in one place, it is a good idea to ask your doctor for an International Certificate of Vaccination and Prophylaxis, which is the official document proving that you have been vaccinated or had another form of prophylaxis before travelling. The „yellow book“ is a sort of medical passport, just as important as a proper one. Rest assured, you can go. Don’t forget to collect your souvenir stamps!



209119



945052



208013



SAFETY FIRST AND FOREMOST!

A WHOLE RANGE OF PRODUCTS TO TAKE WITH YOU WHEREVER YOU GO!



LAPTOP BACKPACK #1707034

THIS IS A BACKPACK THAT CAN TAKE A LOT. A STURDY COMPANION FOR DEMANDING HIKES. EITHER WET OR ROUGH CONDITIONS - THIS BACKPACK CAN TAKE IT. IT WILL MAKE IT THROUGH RAIN AND SNOW.



SIZE: (37L) 39 x 47 x 25 cm
MATERIAL: POLYESTER 1680D
MINIMAL ORDER: 1 pc/colour
MARKING: thermal transfer

- ✓ compartment for 17" laptop
- ✓ headphones socket
- ✓ keychain
- ✓ sunglasses holder
- ✓ 4 mesh compartments
- ✓ 3 pen holders
- ✓ 3 compartments for documents
- ✓ 5 zipped pockets
- ✓ capacity adjustment strips

50 KINDS OF SNOW

Some people are very fond of white landscapes, others less so.



There are, however, people for whom snow is such an inescapable phenomenon, affecting every aspect of their lives, that words to describe it make up a large part of the vocabulary of their language. Northerners, such as the Sami in Scandinavia and the Inuit in Alaska, have around 50 such words. Finnish can describe snow and ice in almost 40 different ways, with separate terms for snow falling on the surface of water - *hyhmä*, a thin layer of fresh snow on ice - *iljanne*, or ice covered with frost - *tökkö*.

GHOSTS AND SHEEP

But it turns out that the language with the most words related to snow, cold and bad weather (which was, and still is, apparently a much-discussed topic) is spoken by a completely different nation.

Researchers at the University of Glasgow are working on a project to create a thesaurus of all Scottish words used throughout history. They have identified over 400 quirky, lesser-known ways of describing winter weather and the circumstances that go along with it (which can be found at scotsthesaurus.org). These include *flukra* - large snowflakes, *spitters* - small snowflakes, *snaw-breaker* - a sheep that clears the way for the rest of the flock in heavy snow, *snaw-ghost* - a snowdrift that looks like a ghost, and finally *snaw-smoor* - suffocation by snow...



WE'VE GOT MORE SUPERB BACKPACKS!



1243087



697034



699034



2100346

WHAT'S THE NICEST ONE?

Air passenger rights organisation AirHelp has been researching the quality of airports and passenger service for years and publishes its findings in an annual ranking. It takes into account around 200 busiest airports and factors such as punctuality, passenger feedback and retail and catering facilities. According to the 2023 study, the top three airports in the world are (in order) Muscat in Oman, Recife/Guararapes in Brazil and Cape Town in South Africa. In Europe, the podium was made up of Bilbao in Spain, Vantaa in Finland and Lech Wałęsa Airport in Gdańsk, Poland.



SIZE: (17L) 36 x 50 x 12 cm

MATERIAL: POLYESTER 1680D, PU LEATHER

MINIMAL ORDER: 1 pc/colour

MARKING: debossing, thermal transfer

- ✓ compartment for 15" laptop
- ✓ 2 mesh compartments
- ✓ 2 handles
- ✓ 3 zipped pockets
- ✓ 4 spacious compartments
- ✓ luggage strap
- ✓ pocket for tablet
- ✓ external USB charging port



LAPTOP BACKPACK #1907034

A COMPACT BACKPACK THAT WILL BEFRIEND YOUR SUITCASE. ATTACHED TO ITS HANDLE, IT WILL ALLOW YOU TO MOVE TO THE GATE AS SWIFTLY AS A CAT. THE ADVENTURE STARTS AT THE AIRPORT ITSELF AND SOME AIRPORTS HAVE TAKEN CARE TO MAKE WAITING TO BOARD AS PLEASANT AS POSSIBLE.

LIGHT AND SOUND

The airport in the US city of Portland has its own little cinema - the Hollywood Theatre. Despite the name, you won't see any major productions here, just independent shorts and documentaries. It's free of charge and, as a non-profit organisation, the cinema is open to submissions for films to be shown on its screen. Another American city, Detroit, offers travellers a true spectacle of light and sound as they pass through the tunnel between the two terminals. The tunnel is lined with glass in topographical patterns and illuminated by LED lights that shimmer and flow along the walls in a somewhat psychedelic way, accompanied by atmospheric music.

EXCEPTIONAL MUSEUMS

There are airports that offer the opportunity to visit museums on their premises. One of these is Istanbul airport, where for 10 euros you can visit a huge, modern exhibition on centuries of Turkish culture. Athens airport invites you on a free journey back to the Neolithic period. There are almost 2,000 exhibits in the Athens Museum, all excavated during the construction of the airport (!). Amsterdam Schiphol Airport has collaborated with the prestigious Rijksmuseum to create the Rijksmuseum Amsterdam Schiphol, a free museum and gallery where passengers can learn about Dutch art and culture. The museum has a permanent exhibition of Dutch masters as well as an ever-changing temporary exhibition.

AND IN THE CITY OF SINGA-PORA LION...

When talking about airport attractions, it is impossible not to mention the one considered to be the greatest in the world - Singapore's Changi. It is a vast complex filled with fabulously designed entertainment and relaxation areas. The entire airport is green and lush with tropical vegetation. There are waterfalls, a butterfly park, a dragonfly garden, a sunflower field and a desert terrace with cacti. Children and adults can have fun on the trampolines, in the ropes course and on the four-storey slide. Nature and entertainment go hand in hand with modern art; the airport is filled with installations by renowned artists, illuminations and multimedia shows. For those who want to relax, there are sleeping areas, spas, swimming pools, cinemas and open-air gardens.

Not too bad!

LAPTOP BACKPACK #2099345

THIS BRAVE BACKPACK IS PERFECT FOR MORE OR LESS OFFICIAL TRIPS, BUT WHAT IF YOUR CAR SUDDENLY BREAKS DOWN ON THE WAY? IN THE MIDDLE OF NOWHERE...

... then the old good institution of hitchhiking might just be the answer.

HITCHHIKING ONCE UPON A TIME

Poland (then the People's Republic of Poland) was the first country in the world to legalise and institutionalise hitchhiking. At the end of the 1950s, the Social Hitchhiking Committee was established. To become a member, you had to have 200 zloty in a savings book, buy a Hitchhiker Around the World ID booklet at the post office, and sign up for accident insurance. The ID booklet was used to record routes and overnight stops. Drivers who picked up hitchhikers were given a cut out coupon with the corresponding number of kilometres. The idea was to encourage drivers to pick up more hitchhikers. Those who collected the appropriate number of kilometres in the coupons could enter a raffle to win attractive prizes. The winner of the „Driver of the Year“ award received a Polish FSO Syrena car.

... AND NOWADAYS

Even after decades, hitchhiking is still alive and well in Poland. You can still see hitchhikers on the side of the road, especially in the summer, waving to drivers with their own handwritten signs with the name of their destination. Hitchhiking has also taken on a new form of regular hitchhiking races, the biggest of which is the Auto Stop Race. It starts annually in Wrocław. More than 1,000 participants, mostly students, race in pairs to reach a given destination as quickly as possible. They have raced to Italy, Croatia, Greece and Spain, among other countries. Once all the participants have reached their destination, a few days of celebration begin.

It makes you want to start packing your backpack!



„Indeed, there exists something like a contagion of travel, and the disease is essentially incurable“.

Ryszard Kapuściński, „Travels with Herodotus“



SIZE: (20L) 35 x 50 x 14 cm

MATERIAL: POLYESTER 900D PU-COATED

MINIMAL ORDER: 1 pc/colour

MARKING: debossing, laser engraving, thermal transfer

- ✓ compartment for 15,4" laptop
- ✓ 3 pockets for documents
- ✓ 5 zipped pockets
- ✓ luggage strap
- ✓ external zipped pocket in the flap
- ✓ 2 mesh pockets
- ✓ external USB charging port
- ✓ 2 pen holders



FSO Syrena



LAPTOP BACKPACK #1239125

LESS IS OFTEN MORE, ESPECIALLY IN THE URBAN JUNGLE. OUR BACKPACK IS DISCREET, VERSATILE AND LIGHTWEIGHT, WHICH IS IMPORTANT WHEN YOU CYCLE TO WORK. NOBODY IS SURPRISED ANYMORE TO SEE STYLISH PEOPLE WITH BACKPACKS, CRUISING AROUND THE CITY IN THE MORNING.

SIZE: (16L) 28 x 40 x 11,5 cm
 MATERIAL: POLYESTER 1580D
 MINIMAL ORDER: 1 pc/colour
 MARKING: thermal transfer

- ✓ compartment for 15" laptop
- ✓ 3 zipped compartments
- ✓ external USB charging port



CYCLING TO WORK

In Amsterdam, 43% of employees cycle to work. Of course, the infrastructure makes it easy - the Dutch capital has more than 500 km of cycle paths and very good traffic lights. Close behind is the Danish city of Copenhagen, where 37% of employees pedal to work every day. Other cycling-friendly cities include Utrecht (Netherlands), Berlin (Germany), Antwerp (Belgium) and Malmö (Sweden).

Peddalling every day not only saves a lot of money on fuel. It's also good for the environment and for your health. Three hours of cycling a week reduces the risk of heart attack by 50%! With the right preparation, it is possible to cycle to work in the rain, in the heat or even in Winter. In Norway, it is even possible to cycle uphill without pedalling at all ...

UPHILL WITHOUT BREATHLESSNESS

It only takes one creative, tired cyclist to come up with a brilliant idea. His name is Jarle Wanvik and he is the designer of the world's only bicycle lift in Trondheim, Norway. Wanvik was fed up with the fact that every day when he rode his bike to work, he would be drenched in sweat and tired by the time he climbed the first hill. So he invented and built a curbside lift that takes cyclists to the top. Cyclists just have to activate the mechanism with their right foot, then slide their foot onto the support (their left foot is still on the pedal) and be pulled up by a conveyor belt installed along the pavement. Inaugurated in 1993, the lift is still in use today and is not only an invaluable aid for local residents, but also a tourist attraction. It is free to use, for everyone!

*„Tell everybody I'm on my way. New friends and new places to see".
 Phil Collins, „On My Way"*



CHECK IT OUT! SUPER BAGS, BACKPACKS AND SO ON!



1232105



604086



1245154

RPET ECO-BACKPACK

#1268159

THIS IS A BACKPACK WITH A MISSION. A BACKPACK THAT PROVES WE CAN MAKE A DIFFERENCE. IT'S MADE FROM WASTE THAT DIDN'T BECOME A TOXIC MASS POISONING THE ENVIRONMENT. IT WENT WHERE IT NEEDED TO GO, TO A PLASTICS RECYCLING FACTORY, WHERE IT WAS TURNED INTO YARN.

SIZE: (10L) 29 x 41 x 11 cm
 MATERIAL: R-PET RECYCLED POLYESTER
 MINIMAL ORDER: 1 pc/colour
 MARKING: thermal transfer

- ✓ compartment for 15,4" laptop
- ✓ 2 compartments for documents
- ✓ 2 zipped pockets
- ✓ pen holder
- ✓ luggage strap
- ✓ smartphone pocket

„We are happy to be in this world. We are bound to it by innumerable threads that stretch from the earth to the stars”.
Rabindranath Tagore

BOTTLES WILL KEEP YOU WARM!

No, we are not mistaken. Besides products like our backpack, RPET yarn is increasingly used in manufacture of hiking- and sportswear. It takes around 35 PET bottles to make one fleece jersey. Can you guess how many of these jerseys you could have after a year of your own consumption?

THE CLIMAT CHANGES

And it's happening as we speak. Ecosystems are also changing, with some species of plants and animals vanishing. Nanoplastic particles are everywhere - in our water, air and food. We can no longer pretend that everything is fine. Ecology is no longer a fashion or a trend - it is a necessity. As a human race, we are only in the early stages of learning how to take wise care of our resources and our home - the Earth. There is still much to learn, but every step in the right direction and every small decision counts.

WHAT IS RPET?

PET, or poly(ethylene terephthalate), is one of the most widely used types of plastic. PET bottles, in which drinks or mineral water are sold, are the most popular and well-known product made from it. The RPET is nothing more than a secondary material produced after recycling used PET bottles and other products. It is a polymer in the form of fibres, which are then used to make fabric for the production of various types of textiles.



I'M MADE OF RPET!*

**material made from used plastic bottles*



Processing PET bottles into RPET is still a developing branch of recycling. However, it has great potential for the future. Secondary production can reduce CO2 emissions by up to 70% compared to the production of conventional PET. Widespread use of this process will also have a significant impact on the reduction of waste to landfill and beyond. Furthermore - the manufacturing of products from recycled materials means less use of natural resources and therefore less pressure on the environment.

SECOND LIFE

Our backpack is thus the second life of many bottles. Our company may even have contributed to this, as we support an organisation that collects litter from the Baltic Sea. We should all remember that our used plastic water bottle should always end up in a properly labelled rubbish bin. **Always.**





2 IN 1 LAPTOP BAG/BACKPACK #548135

SOMETIMES THE WORKPLACE CAN BE SO BEAUTIFUL, WITH THE SOUND OF THE WAVES AND BIRDSONGS, AND THE SEA BREEZE. IT'S TIME TO CLOSE THE LAPTOP AND GET TO WORK AFTER A MORNING COFFEE AND A QUICK READ OF THE NEWS. TO COUNT THE SEALS...

SIZE: (24L) 46 x 35 x 12 cm

MATERIAL: NYLON

MINIMAL ORDER: 1 pc/colour

MARKING: laser engraving, thermal transfer

- ✓ compartment for 17" laptop
- ✓ hide-away handles
- ✓ hide-away shoulder straps
- ✓ pocket for documents
- ✓ 6 zipped pockets
- ✓ adjustable shoulder strap



THE BEST JOB IN THE WORLD

According to a study by Lancaster University, 42% of employees do not have access to a window where they can see greenery. A workplace that is too bright, noisy or crowded increases stress and raises cortisol levels, which affect the way the whole body functions. This can lead to high blood pressure, headaches, obesity and coronary heart disease. Therefore, finding a place to work away from the hustle and bustle of the city and eliminating most of the stressors can improve physical and mental health. Some people are lucky enough to be able to combine work with relaxation and the adventure of a lifetime. By becoming an island caretaker. It's considered „the best job in the world“.



IN TROPICAL PARADISE

Just like in 2009, when Ben Southall (UK) took part in a competition organised by an Australian organisation - Tourism and Events Queensland. The campaign was aimed at the whole world and was simply called „The best job in the world“. It was for a six-month contract as a Great Barrier Reef Island Keeper.

The job involved visiting more than 100 islands around Queensland, writing a blog, taking photos and videos (including the underwater ones) and posting them on social media. Ben beat over 35,000 applicants from around 200 countries and undertook the adventure of his life (made some good money, too!). Sightseeing in the tropics, scuba diving and posting on social media in the evenings - it really does sound like a dream job... Since then, campaigns of this kind have appeared regularly and there is always a call for an island caretaker. There are also campaigns run privately by the owners of the paradise islands, who are often „not at home“.

IN AMBIENT SOLITUDE

Dreaming of regions other than the tropics? There are opportunities for this as well. Glaswegian Jonathan Grant gave up his job in construction to spend 13 years looking after three Scottish islands - Mingulay, Pabbay and Berneray. The last inhabitants left the islands in the 1980s. Therefore, aside from rare visits from adventurous tourists, Jonathan's companions have been mainly seals, sharks and seabirds such as Atlantic puffins and razorbills. Jonathan would begin his work on the islands in April each year (getting there earlier is extremely difficult due to the weather) and finish in the autumn. His duties included surveying animal populations, assessing the general condition of wildlife and archaeological sites (ruins of former settlements) and reporting his findings to the National Trust for Scotland. Jonathan retired happily and said in an interview with the BBC: „It was the best job in the world for me. It's about time someone younger experienced it“.

So how about raw, majestic, beautiful Scotland?

MORE COOL BAGS:



628034

1250105

737034





FROM BREAD TO BUDGET

It begins between 100 and 300 AD with the Roman loculus (small place), a briefcase carried by Roman soldiers as part of their luggage. They were made of goat or calf leather and had a lockable front flap. The loculus contained the soldier's rations and personal belongings. By the 15th century, the Roman Empire had collapsed, but the briefcase was still in use. It was even used by schoolchildren, as we know from Shakespeare's plays. The breakthrough came in the 17th century with the development of pockets (see page 26 for the impact of pockets on women's fashion and comfort). Briefcases were no longer so essential, so they became more specialised, such as the doctor's or soldier's briefcase. Those belonging to the soldiers of Napoleon's army or the Americans during the Civil War had additional shoulder straps. (See our laptop bag/backpack on page 44).

Around the same time, in 1860, the British Prime Minister, who resided at 10 Downing Street, began the annual ritual of presenting the agreed budget for the following year. He presented the public with a red leather briefcase containing all the documents relating to the matter. (The word „budget“ comes from the Latin bolga, meaning a leather bag or briefcase). This tradition continued for the next 150 years, making the briefcase synonymous with finance, economics and business.

MINI-OFFICE

For a long time now, the briefcase has been a clear message to colleagues, clients and basically everyone: „This person has a briefcase and therefore must be important“. Nowadays, business fashion has loosened up considerably, and while fancy briefcases still mean something, most people have moved on to backpacks or briefcases that are modern and convenient (like ours!). After all, the most important feature in the 21st century is space for a laptop, which has become a portable office.

“I don't want to own anything until I find a place where me and things go together”.
Truman Capote
„Breakfast at Tiffany's”



LAPTOP BAG #698034

FROM ROMAN LEGIONNAIRES TO DOWNING STREET TO TODAY'S HANDY LAPTOP BRIEFCASE. TAKE A SHORT, FASCINATING JOURNEY THROUGH THE CENTURIES TO BETTER UNDERSTAND... THE BRIEFCASE.

SIZE: (18L) 41 x 31 x 15 cm

MATERIAL: POLYESTER 1680D

MINIMAL ORDER: 1 pc/colour

MARKING: debossing, colour foil hot-stamping, laser engraving, thermal transfer, UV print

- ✓ compartment for 15,6" laptop
- ✓ 3 pen holders
- ✓ 8 zipped pockets
- ✓ 2 pockets for documents
- ✓ smartphone pocket
- ✓ personal business card pocket
- ✓ luggage strap
- ✓ adjustable shoulder strap



MORE ON THE WEBSITE.
COME AND SEE!



WRITING SETS WITH GEMSTONES

METAPHORICALLY, IT IS A DROP OF PREHISTORY. GEOLOGICALLY IT IS SUCCINITE, THE FOSSIL RESIN OF CONIFERS. ACCORDING TO ASTROLOGY, IT IS THE STONE ASSOCIATED WITH THE SIGN OF ARIES. HOWEVER, IT IS NOT REALLY A STONE. AMBER.



1290036
OBSIDIAN

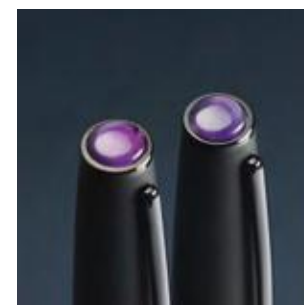

1288036
AMETHYST

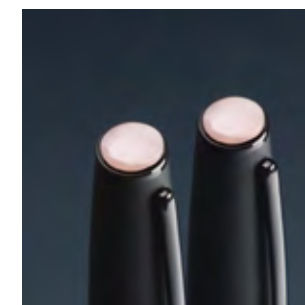

1286036
OPAL

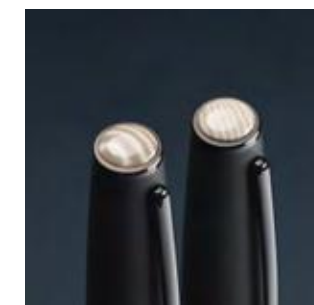

1284036
STRIPED FLINT



1289036
AGATE

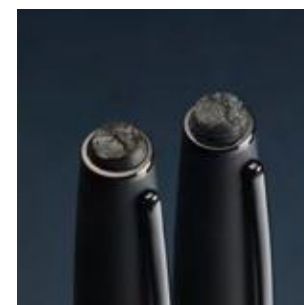

2094036
COAL

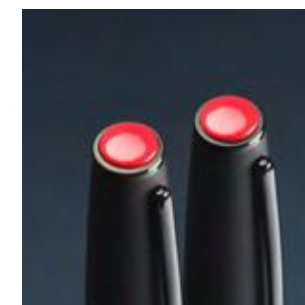

1285036
CORAL

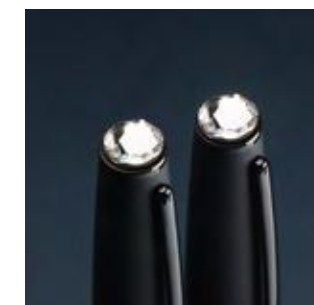

1236036
CRISTAL

WRITING SET WITH AMBER #1235036

SIZE: 18 x 5,5 x 3 cm

MATERIAL: METAL

MINIMAL ORDER: 1 pc/colour

MARKING: laser engraving, UV print

- ✓ contains ink roller and ballpoint pen
- ✓ ink colour - blue
- ✓ box

HOW ABOUT A MORE CLASSIC LOOK?



980036



982036



2070036



GOLD FROM THE DEPTHS

Amber is not a complex mineral rock, but a mineraloid formed from the resin of coniferous trees tens of millions of years ago. It is called „Baltic gold“ because the Baltic Sea is one of its main sources. Baltic amber is also considered to be the most beautiful in the world. It is most abundant between Gdansk and Klaipeda in Lithuania, but that is not all. Rich deposits of amber can also be found hundreds of kilometres away from the Baltic Sea! After all, the world looked a bit different in the Eocene.

AMBER'S NOT ALL ALIKE

Amber is most often associated with cognac-coloured nuggets. However, more than 200 colour varieties of natural Baltic amber are known and described - from bluish, greenish, beige and brown to various shades of yellow and white. The rarest of these is white - hence its high price. The most

valuable and sought after by collectors, however, are amber nuggets with inclusions - specimens of flora and fauna embedded in resin, such as flying insects, scorpions, snakes or... dinosaur feathers.

JURASSIC PARK?

Remember the film „Jurassic Park“? We would like to reassure you that the mosquitoes found in amber so far are mummies, with only the chitinous shell remaining. As a result, scientists have been unable to collect DNA samples from the time of the dinosaurs. Also, the vast majority of these mosquitoes lived after the dinosaurs, so they never had a chance to meet. There is, however, a Lebanese find of two mosquitoes encased in amber from 130 million years ago. At that time, dinosaurs were still roaming the earth. A little blood has been preserved in their shells. Not much can be deciphered from the sample at the moment, but technology is developing at an amazing rate... Is it all just ahead of us?

POWER BANK ORGANISER

#547130

A SERIES OF COINCIDENCES - FROM HER PASSION FOR SPAIN, WHICH BLOSSOMED DURING A STUDENT EXCHANGE, TO THE LACK OF A LABORATORY FURNACE - HAVE PUT OLGA MALINKIEWICZ IN WITH A GOOD CHANCE OF WINNING THE NOBEL PRIZE IN PHYSICS.

SIZE: (A5) 18 x 22,5 cm
 MATERIAL: MERIDA PU LEATHER, CANVAS
 MINIMAL ORDER: 1 pc/colour
 MARKING: debossing, laser engraving

- ✓ 5000 mAh Power Bank
- ✓ smartphone pocket
- ✓ external compartment
- ✓ 3 pockets for credit cards
- ✓ universal charging cable
- ✓ tablet holder
- ✓ pen holder
- ✓ multifunctional holders
- ✓ magnetic closure
- ✓ includes an exchangeable notebook
- ✓ wireless charging
- ✓ paper box



WHY NOT...?



893091



892091

„Energy, energy, energy.
 Yeah, yeah.”
 Beyoncé, „Energy”

SERIES OF HAPPY COINCIDENCES

Perovskites were discovered in the Urals in the 1930s. And that was that. Even though they were known to absorb sunlight and conduct electricity well, they were not used for scientific purposes. Until Olga Malinkiewicz started experimenting with them to make a new type of photovoltaic cell. Initially, her team tried to use perovskites in the same way as conventional crystalline silicon panels - on glass. However, in order to produce a panel of this kind, they needed a furnace that could reach temperatures of 500 degrees Celsius. It was unavailable at the university where they worked, so Olga's idea was to do it on a flexible base and without high temperatures involved. It was the day that revolutionised the approach to solar energy storage.

WHERE'S THE BISON?

The new solar panels are one-tenth the thickness of a human hair and have much better light absorption (and therefore efficiency) than silicon ones. They even absorb artificial light! As a result, the range of solar panel solutions that could come onto the market in the future is remarkably broad. It might be possible to coat cars, lorries and building facades with perovskites. Or to use them in window constructions and boat sails. The bison in the Białowieża Forest are already wearing GPS collars coated with perovskite. This means the batteries are no longer needed and the herds can be better controlled and monitored. This is just the beginning!

WE'RE WAITING FOR THE NOBEL PRIZE!

The icing on the cake is the environmental aspect of manufacturing perovskite panels. There is no waste in the production process and the carbon footprint is ten times smaller than that of conventional solar panels. Storage and recycling of these panels will soon become a major problem. The cells invented by Olga Malinkiewicz are easy to dispose of, simply by burning them in an oven with a smoke filter.

Someday we will certainly offer a perovskite-coated organiser. But until then, we will rely on another form of energy storage - the power bank, which is still indispensable in many situations. In anticipation of the Nobel Prize for Olga Malinkiewicz, our organiser with power bank will help you stay online.

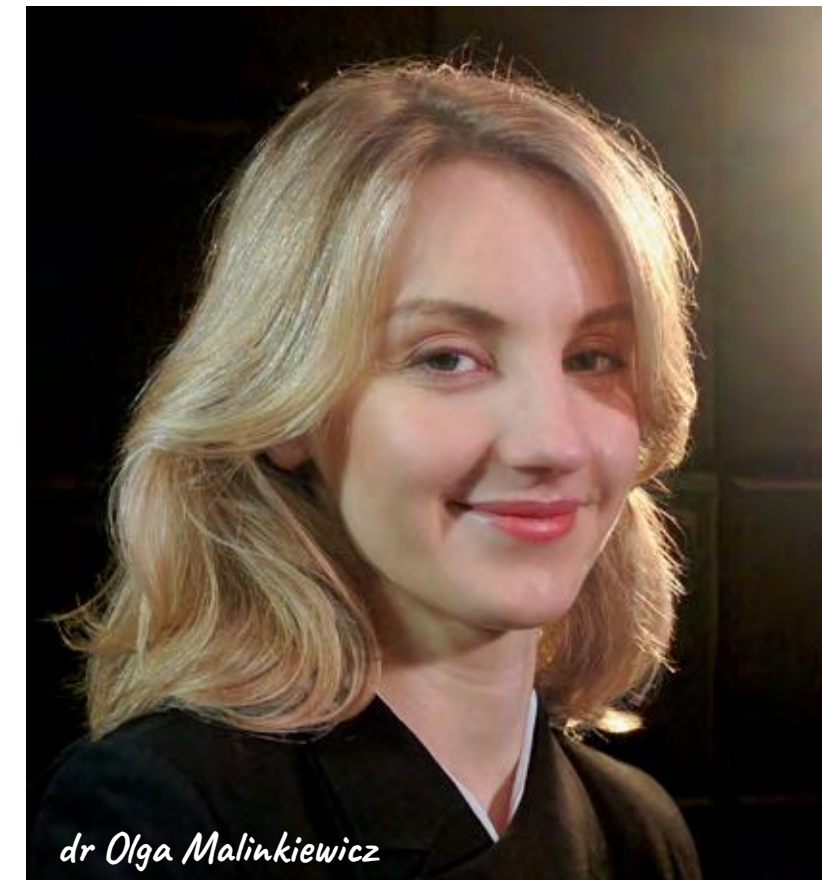

dr Olga Malinkiewicz

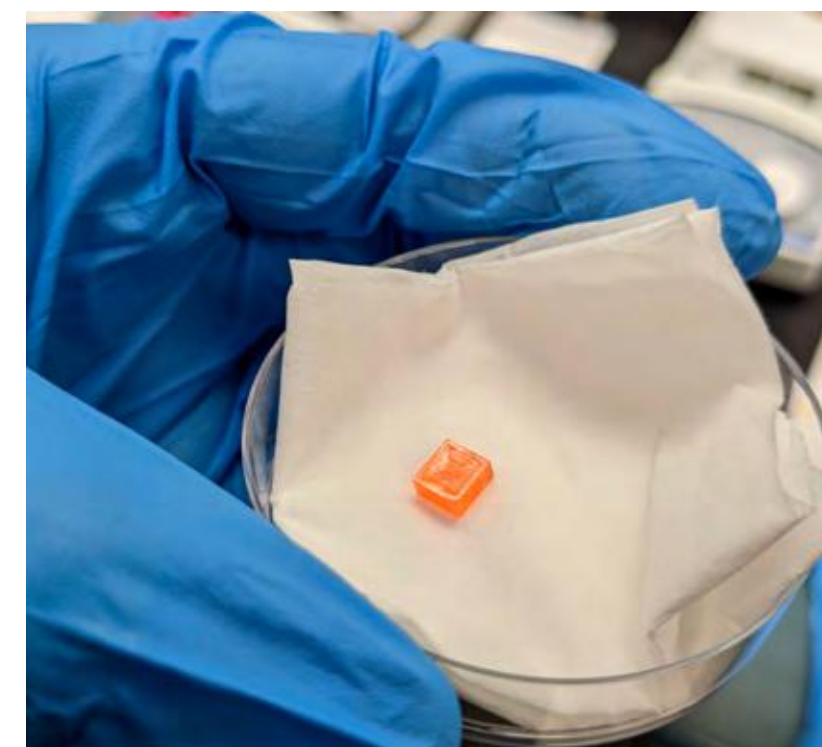

CONFERENCE FOLDER

#106020

WHY DO SCHOOLS KILL CREATIVITY? HOW TO BEFRIEND STRESS? WHAT MAKES LIFE SUCCESSFUL? ARE THERE MICRO-EXTRATERRESTRIALS ON OTHER PLANETS? WHY DOES ENTERTAINMENT GUARANTEE A LONGER LIFE? THESE AND MANY OTHER INTERESTING QUESTIONS CAN BE ANSWERED BY WATCHING TED.



SIZE: (A4) 26 x 35 x 4 cm
MATERIAL: NEBRASKA PU LEATHER
MINIMAL ORDER: 1 pc/colour
MARKING: debossing, colour foil hot-stamping, laser engraving

- ✓ 2 pen holders
- ✓ 3 pockets for documents
- ✓ 5 personal business card pockets
- ✓ zipped compartment
- ✓ clip for notebook
- ✓ binder ring
- ✓ zip closure

THE POWER OF IDEAS

TED, which stands for Technology, Entertainment and Design, is a non-profit organisation dedicated to spreading science and ideas. The scientific conferences have been held regularly since 1984 and are incredibly popular. For many reasons! Very interesting topics, speakers from all over the world, helpful books that expand on the topics discussed and, last but not least, free access to the conference material on ted.com and other platforms. All of this contributes to the success of the event. The TED organisation believes in the power of ideas to change minds, lives and ultimately - the world.

18 GOLDEN MINUTES

It has been researched and confirmed by scientists that the human brain concentrates most effectively on a subject for the first 18 minutes. After that, we are already making some effort to stay focused on the topic. Hence the lecture formula at TED conferences - multiple presenters, each with about 18 minutes (or less) for their talk. This short format ensures that the audience is not bored, and that the speakers compress their content to the point. The formula also assumes a relaxed atmosphere - speakers are entertaining and often throw in jokes. This allows people to absorb information much more easily than if they were listening to a pompous professor. In addition, each conference produces a new batch of short, educational videos in various fields, which are eagerly used by universities and schools to supplement the material.



TAKE PART IN THE CONFERENCE

In line with its own slogan „Ideas worth spreading“, TED conferences have already spread around the world, with local variations known as TEDx conferences. They are open to everyone - you can apply to be a speaker at both official and local conferences. Or buy a ticket, get your conference folder with you - and participate as a attendee. We think everyone would like to hear how to make a sad story funny, or why city flags are often badly designed...

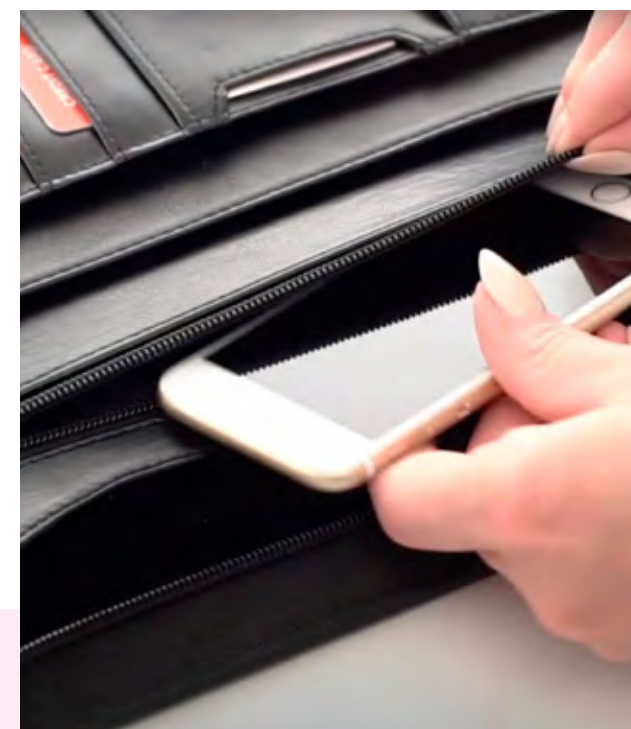

WE ALSO HAVE...



800020



799020



820119



CERTIFICATE COVER #152019

ALBERT EINSTEIN WAS FINALLY ALLOWED TO STUDY AT THE SWISS FEDERAL POLYTECHNIC IN ZURICH. BUT HE FIRST HAD TO IMPROVE HIS MATRICULATION RESULTS. THEREFORE, IN THE RIGHT TIME AND SPACE, HE COULD HAVE RECEIVED THE DIPLOMA IN OUR COVER. AND WHO AMONG THE FAMOUS AND WELL-KNOWN TOOK A DIFFERENT PATH AND NEVER GOT THEIR DEGREE?

SIZE: (A4) 23 x 31,5 cm
MATERIAL: NEBRASKA PU LEATHER
MINIMAL ORDER: 50 pcs/colour
MARKING: debossing, colour foil hot-stamping, laser engraving, UV print
MODIFICATIONS: metal book corners



Mr Steve Jobs and Mr Bill Gates

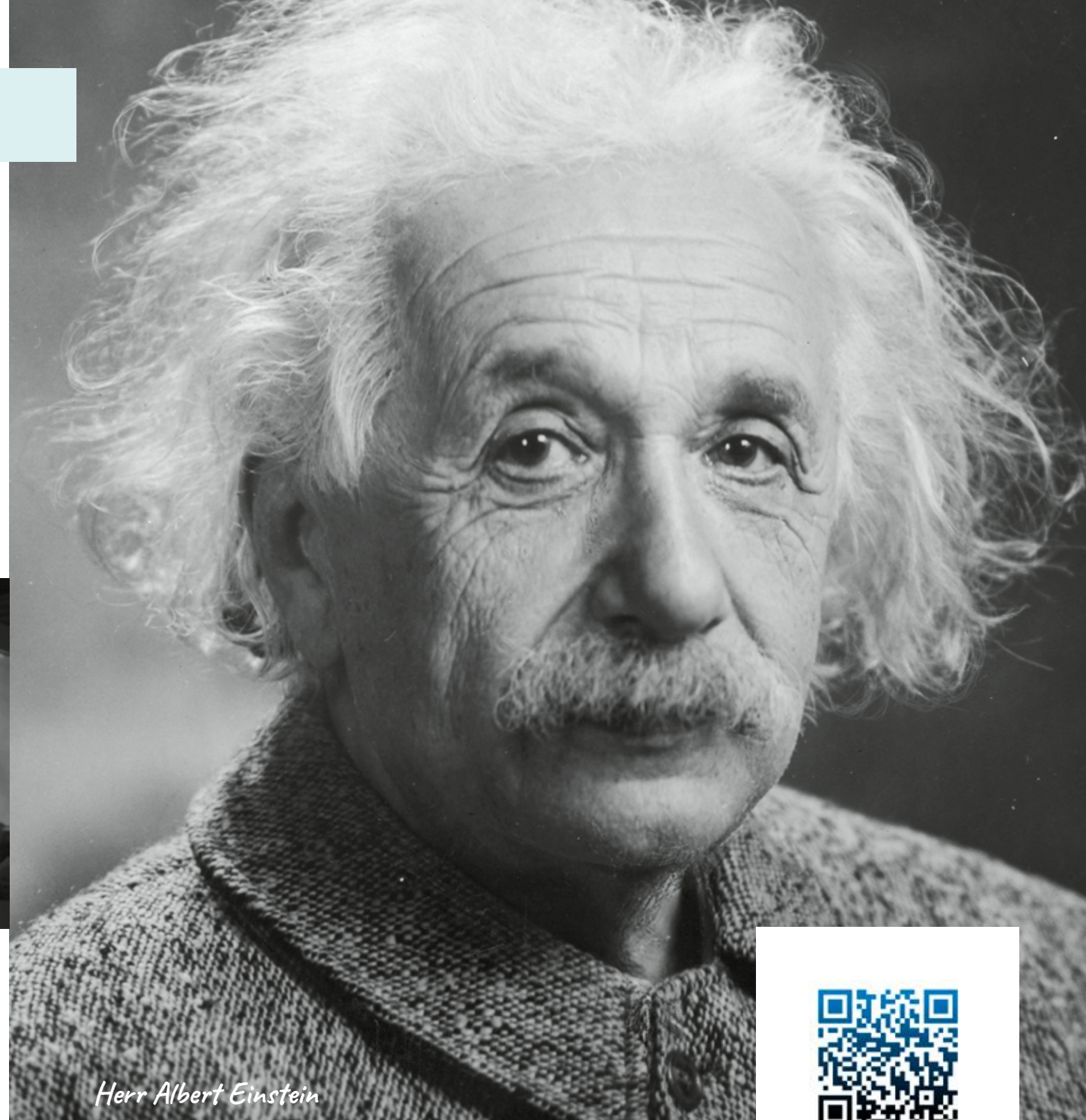

Herr Albert Einstein



NO DEGREE. SO WHAT?

The list of people who have done well without a degree is interesting and quite long.

Coco Chanel, founder of the famous Parisian fashion house, completed her education at the age of 18. As a legal adult, she left the orphanage in which she had been brought up. Celebrated screenwriter and director Quentin Tarantino dropped out of school at 15 to take acting lessons. Microsoft founder Bill Gates and Apple founder Steve Jobs followed analogous paths, failing to complete their law degrees. Liza Minelli not only never made it to university, but dropped out of high school to join the vaudeville stage. The same goes for two-time Oscar-winning actress Hillary Swank. She never finished high school either. The rest is history...

Marc Zuckerberg, founder of Facebook and owner of Meta, did not graduate in computer science. Similarly, Richard Branson, owner of Virgin and initiator of tourist space flights, left school at the age of 16 to start his first business.

Yes, learning is key! But you can learn whenever and wherever you want, not just in the schoolhouse.

*„I don't have any special talents.
 I am only passionately
 curious".
 Albert Einstein*

MORE COVERS FOR SPECIAL OCCASIONS! ↗



152094



1700280



1825117



152326

MAGNETIC NOTEBOOK WITH PEN #1247151

OUR PLANET EARTH, LIKE MANY OTHER CELESTIAL BODIES, IS A GIANT MAGNET. THE SOURCE OF THE MAGNETIC FIELD THAT SURROUNDS THE EARTH IS, AMONG OTHER THINGS, THE LIQUID CORE OF THE PLANET. WITHOUT THE MAGNETOSPHERE, NOT ONLY WOULD WE NOT BE ABLE TO SEE THE NORTHERN LIGHTS. WE WOULDN'T EXIST AT ALL.



SIZE: (A5) 14,5 x 21 cm
MATERIAL: CHAMOIS PAPER, MAGNETO PU LEATHER
MINIMAL ORDER: 1 pc/colour
MARKING: debossing, colour foil hot-stamping, thermal transfer, UV print
MODIFICATIONS: black, red, blue pen colours available

- ✓ touch pen included
- ✓ 80 checkered sheets
- ✓ ink colour - blue

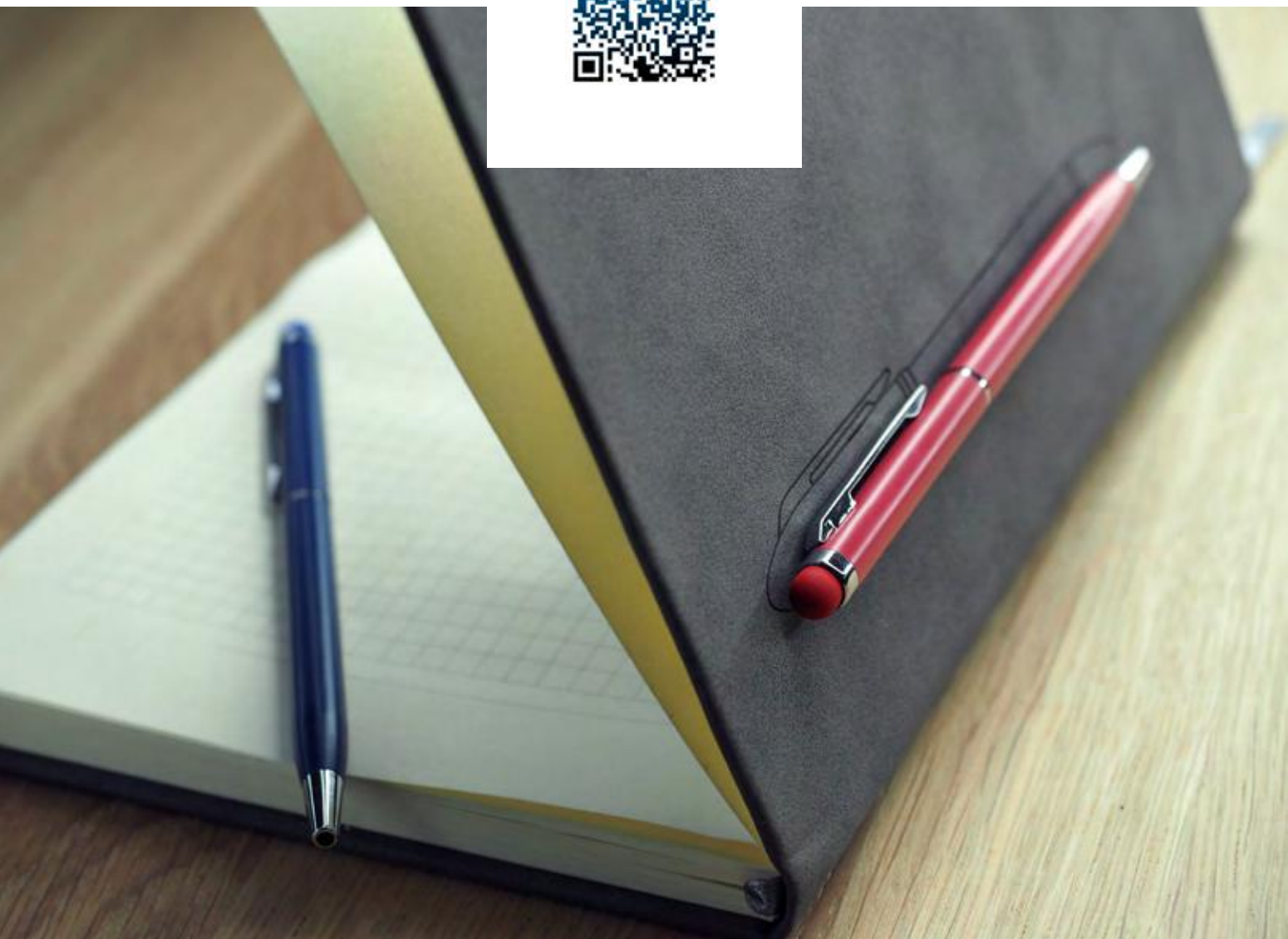

THE WORLD UPSIDE DOWN

The magnetic field extends tens of thousands of kilometres from the Earth, and the area in which it occurs is called the Earth's magnetosphere. Imagine that inside the Earth, more or less along its axis, there is a long magnet bar. Like any other magnet, it has positive charges on one side and negative charges on the other. Here, however, things get complicated and the world turns upside down!

This is because the positive magnetic pole of our planet (i.e. the magnetic south pole) is in the north (where the polar bears are). The negative magnetic north pole is in the south (where the

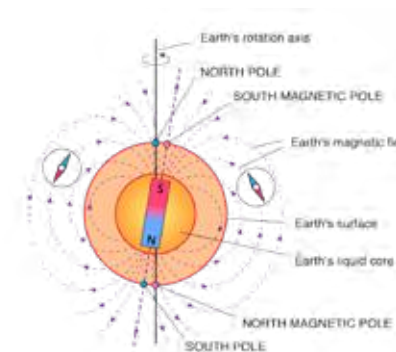

penguins are). This is why the compass needle always points north (approximately, as the geographic and magnetic poles do not exactly align). The coloured end of the needle is negatively charged - so it reacts to positive charges coming from the north. The poles have helped humans navigate for centuries, but we are not the only species to use the magnetosphere for guidance. Sea turtles and birds also use it to navigate during their annual migrations. Interestingly, the deviation of the magnetic poles from the geographic poles is thought to have contributed to the discovery of America by Christopher Columbus. Who is said to have been the son of a Polish king hiding incognito in Madeira. But that's another story...

AURORA BOREALIS

Our protective magnetic bubble plays a key role in protecting the Earth from harmful cosmic influences such as solar wind and cosmic radiation. However, rather than repelling solar wind particles, our large magnet 'catches' them and redistributes them towards the poles - hence the beautiful and fascinating phenomenon of the aurora borealis. Strong solar winds, caused by solar storms, can cause magnetic field disturbances. This leads to disrupted communications and even damaged electrical lines. The aurora, on the other hand, becomes very bright and can be seen at latitudes where it does not normally occur, such as in Poland or even further south. To „hunt“ for it, it is worth following the auroraforecast.com website. It's also worth noting the possible date down. Maybe in our magnetic notebook?

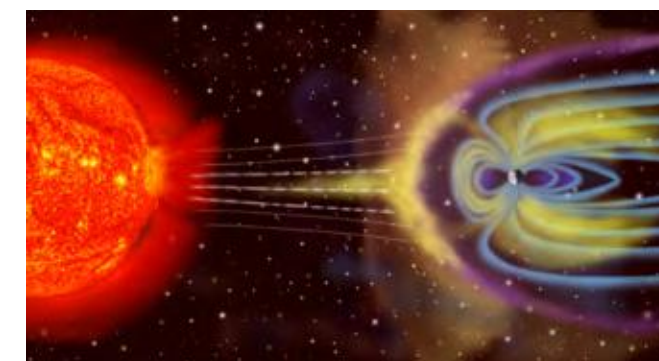

FOR NOTES? POEMS? YOU DECIDE!



823076



1248102



824076



938075



NOTEBOOK #1945318

ALTHOUGH THE KEYBOARD RULES THESE DAYS, WRITING BY HAND STILL HAS ITS UNDENIABLE CHARM. BY COLLECTING NOTES IN A NOTEBOOK, WE ARE, IN A SENSE, THE SUCCESSORS OF MEDIEVAL SCRIBES.

SIZE: (A5) 14,5 x 21 cm

MATERIAL: SPECTRO LEATHER - ANTILOPE, CHAMOIS PAPER

MINIMAL ORDER: 50 pcs/colour

MARKING: debossing, colour foil hot-stamping, laser engraving, UV print

- ✓ 72 checkered sheets
- ✓ impregnated leather

AS A SIDE NOTE...

Medieval manuscripts were massive books on religious, political or legendary subjects, made of wood and parchment. They were written and illustrated by monks called scribes. The manuscripts are known for their rich ornamentation. The most famous and interesting are the so-called **marginalia**, funny drawings in the margins. The most bizarre are called **drolleries**. The monks really let their imaginations run wild! They depicted anthropomorphic animals as knights fighting in tournaments or as perpetrators brutally threatening people (e.g. by decapitation), and the scribes were particularly fond of rabbits. Apparently, the portrayal of such a cute and harmless animal as a human torturer appealed to the medieval sense of humour (yes, we're thinking „Monty Python and the Holy Grail“ here, too!). Monks also indulged their other fantasies. It is therefore surprisingly common to find marginalia of an erotic nature, even in religious books. But that's just an aside...

KISS OF THE MONK

An article by Ann Gibbons entitled „Goats, bookworms, a monk's kiss. Biologists reveal the hidden history of ancient gospels“ was published in the journal Science in 2017. It describes research carried out by an international team of scientists at the Oxford Library. A large number of samples were taken from medieval books. Leather samples were used to identify the animals from which they were made (the aforementioned goat was a surprise). Thanks to the DNA of the woodworms, the exact age of the manuscripts was determined.



Most interesting, however, are the DNA results from the monks themselves. The books were read repeatedly, touched with saliva-slicked fingers to turn the pages - hence the wealth of genetic material left behind. It was possible to identify which texts were read more often and which were less enjoyed. The scientists also discovered the genetic material of many microbes present when people coughed or sneezed. This will add to our

knowledge of the diseases of the time. There were also some interesting surprises. For example, a very significant amount of DNA from one particular person was found on a page depicting Christ on the cross. This page was repeatedly kissed by a Dutch monk, according to what has been discovered. Scientists say that further genetic analysis could reveal information such as his diseases, eye colour or hair colour.





„Nature always seems trying to talk to us as if she had some great secret to tell”
John Lubbock

CRAFT ECO NOTEBOOKS

FROM LANDFILLS, PLANTATIONS, COFFEE AND TEA FACTORIES, PARKS AND RESERVES. OUR TREELESS NOTEBOOKS NOT ONLY HELP TO SAVE FORESTS, BUT ALSO TO CLEAN UP A BIT.

SIZE: (A5) 14,5 x 21 cm
 MATERIAL: ECO-FRIENDLY RECYCLED PAPER
 MINIMAL ORDER: 1 pc/colour
 MARKING: UV print

- ✓ 80 lined sheets
- ✓ wheat straw paper
- ✓ sample of recycled material included

THIS IS STILL USEFUL!

An uncle, grandma and grandpa, a brother-in-law - most of us remember or have someone in our family who used to keep 'junk'. Someone who found it difficult to throw away a piece of wire or an old washing machine because it could still be useful in some way. And that was often true. In the past, almost nothing was thrown away. Objects and appliances were repaired and improved at the family's own expense. They were given a second, sometimes even a fourth or fifth life. A coffee grinder could become a flower pot, and the case of a broken TV could become a comic book shelf. It was an advanced form of domestic recycling - before anyone had even heard the word.

THE MATERIAL AROUND US

In this age of a return to the philosophy of re-use of materials, all it takes is a careful look around. The leaves left at the bottom of your cup after your afternoon tea are a great material to recycle! And it's not just them - coconut shells, banana palms (which only bear fruit once) or some of the waste from elephant herds that pile up in the world's natural parks and reserves. In combination with the pulp from cotton rags, they make a very attractive craft paper.

THIS TRULY WAKES YOU UP

An average of 10 million tons of coffee is consumed worldwide every year. The process of removing the husk



2097340
TEA
65% tea leaves
35% cotton rags



2097339
COFFEE
65% coffee husk
35% cotton rags



2097342
BANANA
70% banana fiber
30% cotton rags



2097343
HEMP
70% hemp
30% cotton rags



2097341
COCONUT
60% coconut husk
40% cotton rags



2097344
ELEPHANT POOP
95% elephant poop fiber
5% cotton rags

from the beans generates millions of tons of waste. However, this humble husk, which is usually discarded, is a cellulose-rich material and its reuse means that no trees are needed to make paper. Sourcing these husks from the small coffee plantations has another benefit - it provides farmers with an additional income, stimulating the local economy and improving their standard of living. The recycling of this type of waste also reduces greenhouse gas emissions by reducing the amount of methane produced by the decomposition of pulp in landfill sites.

ECOLOGY IN THE NUTSHELL

The exotic fruit of the coconut is not only delicious and healthy, it is also sustainable. Few people know that the fibre of the coconut husk (found between the hard shell and the outer layer of the nut) is a cellulose-rich material that can be used to make paper. And it's true! One ton of coconut husk saves the equivalent of 12 trees that would be needed to produce the same amount of wood pulp. The future of paper production could be less harmful and painful to the environment if coconut husk paper production is implemented on a larger scale.

SINCE IT IS POSSIBLE...

... then let's reuse. Using the same things over and over again may have been a bit embarrassing in the past (shredded jumpers and pulled-out tracksuits from your cousin), but it's very fashionable now. Why throw something away when it can be used? It will come in handy!





LUGGAGE TAG

#1155317

DELICIOUS, AROMATIC AND HEALTHY APPLES HAVE A WIDE RANGE OF USES: JUICES, CIDER, CAKES, MOUSSES, CHUTNEY, WINE. AND LUGGAGE TAGS.

SIZE: 16,5 x 6,5 cm

MATERIAL: VEGAN APPLE PU LEATHER

MINIMAL ORDER: 50 pcs/colour

MARKING: debossing, colour foil hot-stamping, laser engraving, UV print



APPEALING APPLE PEEL

Apple PU leather is made from the leftovers from the pressing of apple juice. The skins, stalks and fibres are ground into a fine powder. This is then mixed with organic pigments, polyester, polyurethane, cotton and viscose. The end result is a material that is 40% apple & 100% vegan. It is a soft-touch alternative to natural leather of animal origin and we used it to make this luscious apple luggage tag.

EXCUSE ME, WHERE'S MY LUGGAGE?

It is estimated that between 25 and 30 million pieces of luggage are lost at airports each year (around 8 per 1,000). Unfortunately, only a few of these bags are returned to their owners.



1155094



1155119



1155140



1821113



THAT'S NOT ALL! CHECK OUT OUR OTHER TAGS!



The record belongs to American April Gavin, whose suitcase went missing during a short business trip to Chicago. Four years after the incident, April received a call from United Airlines telling her that her luggage had been found and was on its way back from... Honduras.

RETURNS AFTER YEARS

This is just one of the uplifting stories of objects found years later. An angler was fishing in his favourite lake, Attersee in Austria. He pulled out a fishing net to find out there was his own wallet caught in it. The same that had fallen into the lake 20 years earlier. An American professor happened to buy a used book on Amazon - the same one she lost five years ago. A gardening enthusiast found her wedding ring after 16 years - stuck in a carrot.

CHEERS TO TIM!

Sometimes, however, an unfortunate misplacement can lead to something completely unexpected. London-based Guardian journalist Timothy Burrows lost his wallet at the Reading Festival in 2003.

The wallet was found by a group of young men who, before handing it over to the Lost and Found, „borrowed“ £10. (A pun - Burrows sounds the same as „borrows“). They used this extra budget to buy cheap, strong White Lightning cider (hello, apples!). Since then, in honour of the event and the unwitting sponsor, the mates have met every year to compete in drinking strong cider in time. They called the competition the Timothy Burrows Drinking Challenge, a name that also became a catchphrase within the group - e.g. „I'm going to the pub, meet Tim Burrows“.

After 14 years, one of the men decided to track down the wallet's owner. So he wrote to every Tim Burrows he could find on social media. With a successful outcome - he managed to contact the real Tim, apologise for the „loan“ and tell him the whole story, which Tim, being a journalist, naturally published. The post went viral and competitions named after Tim Burrows sprang up all over the place. Timothy himself met up with his long-time „fan club“ to enter a competition named after him. His new friends also returned the £10 he lent them 14 years ago...

WHAT DID YOU FIND??

Unclaimed Baggage, a US company based in Alabama, has been buying up unclaimed luggage from airlines for more than half a century. Some of the contents are donated to charity, while the rest ends up on shop shelves. They started with a small shop that quickly grew to the size of a supermarket. During the COVID 19 pandemic, the offer also appeared online. The most interesting finds make it to the collection of a small museum you can visit while shopping. And there is plenty to see there! Items include medieval armour, a space camera (which was sent back to NASA after a brief exhibition), an Indian peace pipe, a shrunken human head from Peru and much more. Worth a look at [unclaimedbaggage.com](https://www.unclaimedbaggage.com)!





HIP FLASK #425131

DESPITE THE SHIVERRRRRING AND THE NUMB FINGERS - THE COLD CAN BE GOOD FOR YOUR HEALTH AND CAN IMPROVE YOUR MOOD. WHAT DOES THE SCIENCE SAY?

SIZE: (240 ml) 9,5 x 15 cm

MATERIAL: STAINLESS STEEL, ITALIA LEATHER

MINIMAL ORDER: 50 pcs/colour

MARKING: debossing, colour foil hot-stamping, laser engraving, UV print

- ✓ 240 ml capacity
- ✓ paper box

HOW DOES IT WORK?

The therapeutic effects of low temperatures have been known for centuries. Formerly known as cold therapy, it gained its current name - *cryotherapy* (from the ancient Greek words *krýos* - cold and *therapeía* - treatment) - in the 1970s.

There are two phases of the exposure to the cold. The first is the ischemic phase, during which muscles and blood vessels contract. This slows down metabolism and circulation, creating a numbing effect. In the second (post-exposure) phase, known as reperfusion, the blood vessels rapidly dilate to warm the body through accelerated blood flow. As a result, tissues and organs are much better supplied with oxygen, which reduces pain and inflammation, speeds up recovery, relaxes the body and makes joints more flexible. It also increases cardiovascular fitness, aids post-exercise recovery, promotes weight loss and improves skin condition. Cryotherapy also leads to powerful releases of hormones and neurotransmitters, including beta-endorphins, adrenaline, or noradrenaline. These improve mood, increase resistance to stress, give an „energy kick“ and significantly improve sleep quality.



THERE ARE MORE! TAKE THE FLASK ON THE WAY!



1902036



425325



426131



426119

BUT HOW? IT'S SO COLD!

Step by step. Experts recommend starting with cold showers - this is the easiest and safest way to develop cold tolerance. The next step could be so-called snow dry baths. Rubbing or rolling in the snow gives you much more exposure to low temperatures, but also the opportunity to adapt it to your level of tolerance and comfort. It's not as direct as getting immersed in icy water, but the benefits are the same. The last step is full immersion, or „winter swimming“. Initial sessions should be short, lasting between 30 and 60 seconds. An experienced „winter swimmer“ can stay in the water for up to a few minutes, and doctors recommend a frequency of 1-2 times a week. A gentle warming up should be done before immersion, followed by a quick change into dry clothes and a cup of hot tea.



Mr Wim Hof

ICEMAN ADVISES

The most extravagant form of cold exposure is mountain walking in summer clothes (or even just shorts). This is an activity reserved for very experienced ones. The biggest inspiration for many of them is the Dutchman Wim Hof, known as the „Iceman“, and his method of overcoming the body's reaction to prolonged cold.

Hof is known for his incredible ability to regulate his body temperature, and his sporting achievements as a result. These include bathing in ice for almost two hours, during which he managed to keep his body temperature from dropping by as much as 0.3 degrees Celsius. He has climbed Mount Kilimanjaro wearing only shorts and boots. He ran a marathon in the sub-zero temperatures of Finland in 5 hours and 25 minutes, wearing only a pair of shorts...

There are three pillars to the Hof method. The first, of course, is the low temperature to which you are exposed. The second is breathing exercises, which help to control lung reactions, prevent hyperventilation and accustom the body to a high level of oxygen in the blood. The third is derived from meditation techniques and aims to work on the mental attitude, which, when properly „calibrated“, leads to patience, concentration and determination. Wim Hof trains instructors in his method and his organisation, Innerfire, has a centre in Przesieka in the Karkonosze Mountains, Poland. The centre offers week-long courses that include exercises, meditation, ice baths, and a hike to the Snieżka mountain in summer clothes.

After this exciting dose of cold - enjoy a hot dinner and a mug full of steaming grog!

GROG RECIPE

- 250 ml of hot water
- 30 ml of rum (which was stored especially for this moment in a flask)
- 1 teaspoon of honey or cane sugar
- 3 tablespoons of lemon or lime juice
- 1 teaspoon of warming spices: cloves, cinnamon, star anise, nutmeg, grated ginger

Pour the sugar into a warm mug, add the lemon juice and stir.

Then add the spices, rum and hot water.

Cheers and good night!



COSMETIC BAG #540059

A VAN HELSING-LIKE (COSMETIC) BAG! WHAT IS IN IT?
A THISTLE STAKE, GARLIC, SILVER AMMUNITION?
NO. IT'S A REPELLENT.



MEET THE VAMPIRE

It's better to know your enemy. Here are a few facts about mosquitoes.

There are over 3,000 species of mosquitoes, but only the ladies attack us. Females need the protein of human blood to reproduce (males are vegan). They lay an average of 100 eggs at a time and the young mosquito becomes an adult within a week. Males do not enjoy adulthood for long, as their maximum lifespan is 10 days. Females, on the other hand, have a much longer lifetime - 6 to 8 weeks and up to six months in hibernation! The only role of the males is to take part in a mating ritual, just like the one in the „Dirty Dancing“ film, when the mosquitoes pair up with individuals with the most similar ... rhythm and speed of wing beat. And these can beat up to 600 times a second! Hence the most annoying vibrating sound...

FAVOURITE MENU

Some females „eat“ twice as much as they weigh in one sitting - it's like a 60kg person eating a 120kg meal for dinner. Their favourite menu are considered to be pregnant women and (according to a 2011 French study) beer drinkers. Easiest to spot are people dressed in black or red.

If you are one of those people that mosquitoes are particularly fond of, you should know that your tormentor can smell you from 50 metres away and will be planning a meal from afar. They are attracted to the carbon dioxide exhaled by humans, but if you eat chocolate or a salad with mint beforehand, the vampire will be confused. To prevent, such frequent, bites on your feet and ankles - wash your feet. Mosquitoes love the smell of stale feet, which for them is an invitation to feast.

TREATMENT & PREVENTION

Mosquito activity increases by around 500% during a full moon. So if you're planning a barbecue with friends on a bright moonlit night, make sure you have repellent and a small bowl of... burning coffee on the table. This incense will ward off hordes of vampire bloodsuckers. If one does get you, the bite is very itchy and you don't have the right salve - baking soda, aloe vera, camomile, arnica gel, honey or oatmeal may help.



439013

527322

1223059

527055

FIND NICE
COSMETIC
BAGS HERE:



SIZE: 21 x 11 x 9 cm
MATERIAL: SAFFIANO PU LEATHER
MINIMAL ORDER: 1 pc/colour
MARKING: debossing, laser engraving



KEYRING #909095

A KEYRING AS CHIC AND ELEGANT AS THE LITTLE BLACK DRESS - FOREVER FAMOUS THANKS TO AUDREY HEPBURN...

SIZE: 11 x 2,5 cm

MATERIAL: PESARO LEATHER, METAL

MINIMAL ORDER: 1 pc/colour

MARKING: debossing, colour foil hot-stamping, laser engraving

- ✓ 3 key rings
- ✓ paper box



... or like Darth Vader's robe! There are also some „black“ days. To learn more about two of them, let's travel to the United States of America.

BLACK THURSDAY

It was 24 October 1929 when the crash of the New York Stock Exchange on Wall Street triggered a crisis that spread around the world. Ten years later, then US president F.D. Roosevelt realised that a change in the calendar of American holidays could have a tangible economic impact. To stimulate the economy, he moved Thanksgiving from the last to the fourth Thursday in November. The change may seem small, but it added an extra week to the pre-Christmas shopping rush. Which officially starts right after Thanksgiving.

Having a Thanksgiving Thursday off doesn't really motivate anyone to go back to work the next day, so...



By GORDON S. WHITE Jr.
 Special to The New York Times
 PHILADELPHIA, Nov. 28
 Philadelphia police and bus drivers call it "Black Friday" —that day each year between Thanksgiving Day and the Army-Navy game. It is the busiest shopping and traffic day of the year in the Bicentennial City as the Christmas list, is checked off and the Eastern college football season nears conclusion.

BLACK FRIDAY

In the 1950s, it became extremely common in the US for people to call in sick on the Friday after Thanksgiving. The employers would take a loss and the „sick“ would win a long weekend and head out en masse to do their first round of pre-Christmas shopping. In Philadelphia, this also coincided with the annual big event - a football game between the Army and Navy teams. The city was therefore overcrowded, which had to be managed by police officers who not only could not take time off, but also had to work overtime. It was them - overworked and unhappy - who coined the term that has become part of the culture and that we still use today - Black Friday.

Black Friday is now a public holiday in the majority of US states, and the shopping frenzy of the day has become a tradition that has spread across the world.



KEYRINGS & MORE KEYRINGS. CLASSIC AND WITH A TWIST. SEE THEM ALL!



609124



915095



914095



913095

KEYRING #178011

THE INVENTOR CONSIDERED TO BE THE FOREFATHER OF MODERN KEYRINGS WAS THE OWNER OF TWO THRIVING SHOE FACTORIES. HE WAS ALSO GIFTED WITH A GREAT VOICE, WHICH TOOK HIM TO THE COURT OF QUEEN VICTORIA...

MATERIAL: EXCLUSIVE LEATHER
MINIMAL ORDER: 100 pcs/colour
MARKING: debossing, colour foil hot-stamping, laser engraving, UV print

- ✓ custom edge and thread colour available
- ✓ paper box



MULTITASKING AT A HIGH LEVEL

Fredrick J. Loudin was an African American, the child of free farmers in Ohio. He excelled in education and was one of the few black citizens to graduate from college at the time. A gifted musician, he composed, taught music and conducted a choir. But that was not all - he was also a businessman who successfully ran a large shoe manufacturing business. Although he spent several years touring the continents as a member of an African-American gospel choir called the Fisk Jubilee Singers (singing for Queen Victoria of the British Empire, among others), he found time to invent and patent (in 1864) what is believed to be the first keyring.

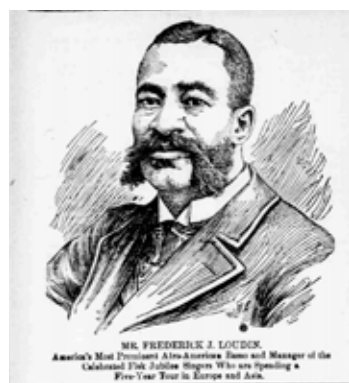

SPECIAL PURPOSE KEYRING

From our point of view, the resemblance of the so-called „key clasp“ by Loudin to a keyring is only slight. However, given that the clasp was permanently attached to the key and the key was carried with it, it comes closest to the definition of a keyring definition. So what was this clasp for?

It was an anti-burglary system. Firstly, it was permanently attached to the key, making it difficult to lose. Secondly, once the key was inserted into the lock, it prevented the key from being removed from the outside. Thirdly, it prevented the door knob from being turned, by enclosing the key in the lock and the knob at the same time. Sadly, racism prevented Loudin from getting the full credit he deserved. However, his memory lives on, and we are here to pass it on to you.

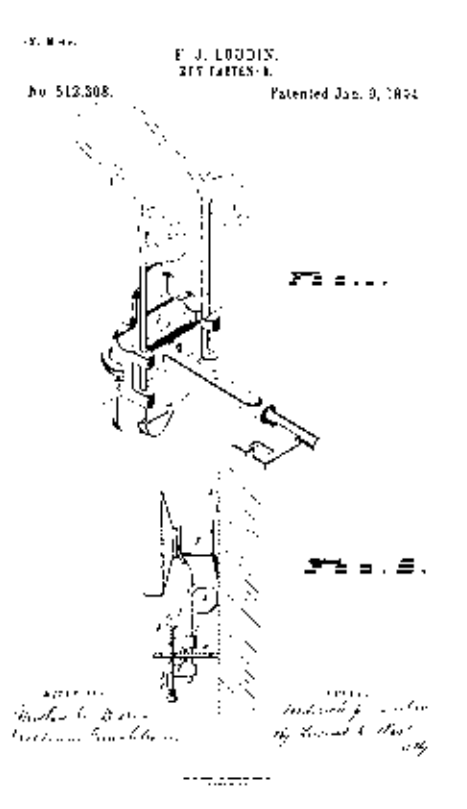

MAKE A KEY DECISION AND CHOOSE YOUR KEYRING SHAPE:

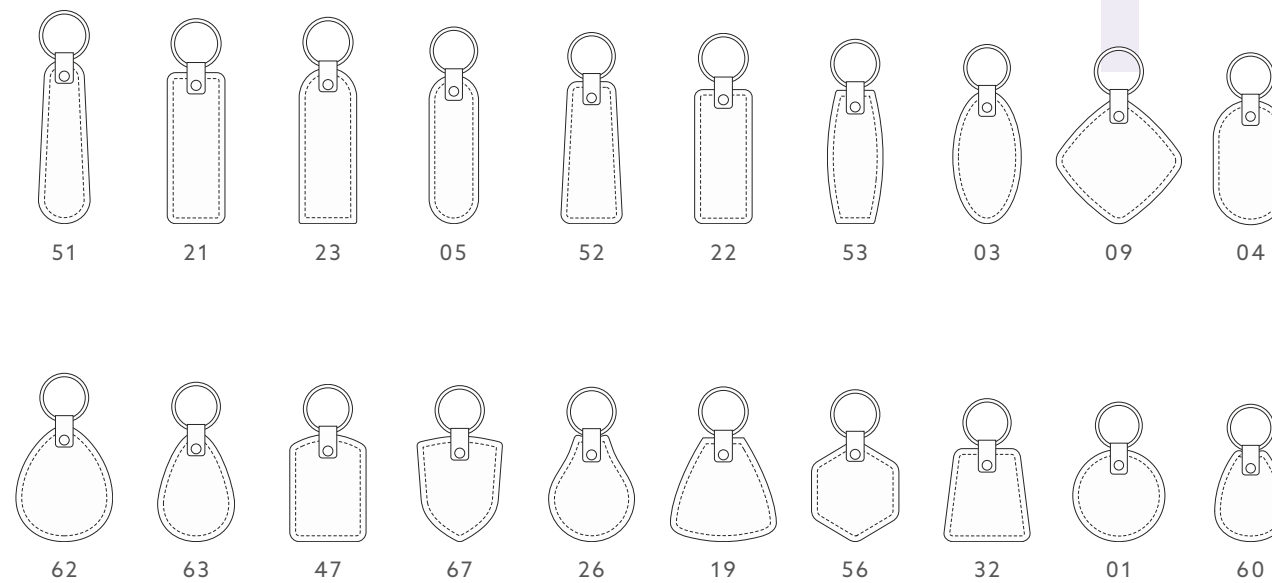

SCAN AND DISCOVER THE MANY WAYS YOU CAN CUSTOMISE YOUR KEYRING. CHOOSE THE TYPE AND COLOUR OF MATERIAL, THE COLOUR OF THE EDGE AND MANY OTHER OPTIONS. WOW, SO MANY POSSIBILITIES!!! :D





KEYRING WITH AIRTAG POCKET

#1914141

KEYS GIVE THE IMPRESSION OF THINGS MADE TO BE LOST. SMALL, ALWAYS ON THE MOVE, PUT IN DIFFERENT PLACES. IF YOU'RE #TEAMIPHONE, YOU CAN START TRACKING THEM DOWN - THANKS TO BLUETOOTH TECHNOLOGY.

SIZE: 4,3 x 9,5 cm
MATERIAL: PRIMAVERA LEATHER
MINIMAL ORDER: 50 pcs/colour
MARKING: debossing, colour foil hot-stamping, laser engraving

- ✓ round snap hook
- ✓ paper box
- ✓ keyring does not contain AirTag

HOW DOES IT WORK?

The Bluetooth module, which allows electronic devices to communicate with each other, is a small component that acts as both a transmitter and receiver of radio waves. Pairing it with a second module provides two-way connectivity, i.e. the ability to transfer data (e.g. files) from one device to another over short distances. The range of a Bluetooth connection is typically between a few and 10 metres, depending mainly on the physical obstacles in the way (such as a thick wall).

So how is it possible for the Apple AirTag we sent in a parcel to another country to communicate with our smartphone?

AirTags use a global network of all active Apple devices. They send out an encrypted Bluetooth signal that is picked up by nearby Apple devices. These devices then share the tag's location data with iCloud. When you activate the corresponding app on an iPhone or computer that is paired with the AirTag, you can see its location on a map.



Konge Harald Blåtand

WHY THE BLUE TOOTH?

Bluetooth technology is named after Harald Bluetooth, the first Danish king who lived in the 10th century. The king, known in his own country as Harald Blåtand, got his nickname because of a necrotic tooth that had been partially knocked out in a battle or accident. Harald conquered Norway and southern Sweden, helping to unite the rival chieftains known as the Jarls.

The author of the Bluetooth concept, the Swede Jim Kardach, was fascinated by the history of Bluetooth and decided to name a technology that „unites“ devices of different types in his honour. As a result, the Bluetooth logo features two runes from the Futhork junior alphabet - *haglaz* and *berkanan*, the initials of the Viking king.

In this way, Harald was permanently commemorated and his nickname and initials accompany all users of electronic devices every day.

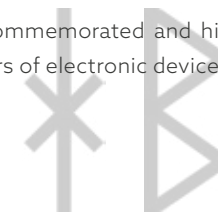

KEYRINGS WORTHY OF KINGS



1709094



2041141



1710141

PRINTED PAPER COASTER

#1839117

PRINTED COASTERS OFFER ENDLESS POSSIBILITIES FOR SELF-EXPRESSION OR MARKETING. WHETHER IT'S A LOGO, A CATCHY SLOGAN OR A FUN GRAPHIC - JUST TELL US WHAT YOUR VISION IS AND WE'LL MAKE IT HAPPEN!

SIZE: 10 x 10 cm
 MATERIAL: CARDBOARD
 MINIMAL ORDER: 50 pcs/colour

COASTERS WITH HISTORY

The history of cardboard coasters dates back to the 19th century when the first ones appeared in Germany. They were, of course, used as pads for beer mugs and also as an advertising medium for breweries. A beer coaster? Of course - if that is what you want. After all, the printing possibilities are endless!

THANKS, JOHANNES!

The great-grandfather of all printers was Johannes Gutenberg, who in the 15th century built the groundbreaking printing press that laid the foundation for all subsequent printing innovations. We owe Herr Gutenberg a debt of gratitude and are happy to use his invention in a modern form. **Our company owns a professional digital printer** and we use it without hesitation for our and our customers' needs. Among other things, we produce colourful, personalised packaging (see page 12), flyers, posters, etc. We also make the aforementioned cardboard coasters or hotel DND door signs.

Have you got your own idea? Let us know!



DID YOU KNOW THAT...

The smallest book in the world was made in Japan. It measures 0.75 millimetres (it fits through the eye of a needle) and the width of its letters is less than 0.01 millimetres. It also contains illustrations showing the Japanese flowers it is about. A copy can be purchased (not cheaply) from the Tokyo Book Museum, along with a magnifying glass and a larger version of the book.

The largest book in the world can be seen in Dubai. It is 5 metres, 8.8 metres high, and weighs 1,500 kilograms. It tells the story of the life of the Prophet Muhammad and the influence of Islam on world culture.

The world's thickest book, on the other hand, was published in Germany and is called „Das dickste Buch des Universums“, which literally means „The thickest book in the Universe“. The book is over 4 metres high, has 50,506 pages and weighs 220 kilos. Its authors are... children. The book contains texts and drawings on the subject of road safety and was written by 40,000 kids.



CHECK OUT OTHER PRINTED PRODUCTS



LET'S PRINT SOMETHING TOGETHER!



DESK ORGANISER #1818121

BIRCH AND ALL OTHER TREES ARE OUR ALLIES, HELPING TO HEAL OUR BODIES AND MINDS.

SIZE: 21 x 11 x 1,5 cm

MATERIAL: BIRCH PLYWOOD, ALTARA

MINIMAL ORDER: 50 pcs/colour

MARKING: debossing, laser engraving

MODIFICATIONS: Altara colours available - ecru, black, grey, brown, light green, turquoise

- ✓ metal badge for engraving included
- ✓ paper box



SHINRIN YOKU

This is what the Japanese call walking among the trees, which literally means a forest bath. **Karoshi** is what they call death from overwork. In a way, forest bathing is a return to the roots. It is an answer to the widespread phenomenon in Japan of working beyond one's strength, which destroys physical and mental health. The first nature therapy centre was established there in 1982. The effectiveness of this practice, which originated in Buddhism and Shintoism, attracted the interest of scientists who recognised its validity and effects. Forest therapy centres and workshops are now available all over the world, but you don't have to use anyone's services to practise Shinrin Yoku. All you have to do is go to the forest. The Japanese recommend a walking pace of 1-2 km per hour, trees of at least 5 metres in height and a forest belt of at least 20 metres in width.

It is important not to use the phone. Walk quietly and if your thoughts are racing, let them flow until they calm down. The essence of forest bathing is to immerse yourself in the atmosphere of the forest and absorb it with all five senses - sight, hearing, taste, smell and touch.

USE PHYTONCIDES!

To enhance the effects of touch, many people practice „tree hugging“. **Sylvotherapy** (from the Latin *silva* - forest), which involves hugging trees, is based on elements of meditation and the scientific knowledge that trees can actually help us feel better. This is because they release phytoncides that not only protect them from parasites and bacteria, but also inhibit the growth of fungi, viruses and protozoa. In other words, they are a kind of antibiotic for the trees. Interestingly, one hectare of deciduous forest (the one with leaves) produces about 2 kg of phytoncides in the summer, while the same area of coniferous forest (the one with needles) releases about 5 kg of these substances.

Phytoncides are also beneficial to humans - they act as antiseptics, cleanse the respiratory tract, regulate the heart rate and have a calming and protective effect on nerve cells. They are responsible for the waves of happiness and relaxation you feel when walking in the woods or huddling in the trees. They put us at rest, reduce muscle tension and improve overall health.

So if you are overtired, want to boost your immunity and reduce stress - go to the forest and cuddle up to a tree...

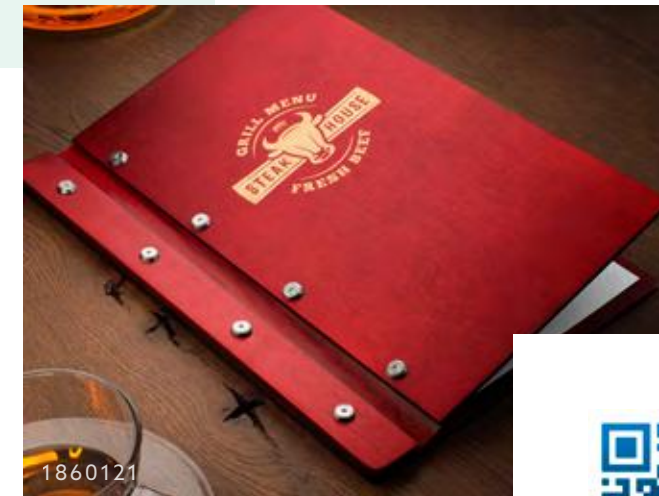

1860121



1843121



2016121



1853121





BOX #1631106

A DECORATIVE, ENVIRONMENTALLY FRIENDLY BOX MADE OF PAPER. BECAUSE PAPER IS A SUPER-MATERIAL!

SIZE: 17 x 17 x 3 cm

MATERIAL: WASH PAPER

MINIMAL ORDER: 20 pcs/colour

MARKING: laser engraving, thermal transfer

WHAT IS WASH PAPER?

The box is made from Wash Paper (also known as Washpapa, Washable Craft Paper) - a material made of cellulose fibres from recycled wood. The wood content can range from 60 to as much as 90%. Natural pigments (up to 2% of the composition) and 4 to 6% of water are also added to the material, and the binding agent is a synthetic latex.

WASH IT FOREVER!

Many people don't realise that they use wash paper very often. In fact, many brands use labels made of this material, which are sewn onto the back of the trousers. The most famous - Levi's - have not changed their design since 1937, when they were patented. Before they were made of printed paper - they were made of leather, with the logo and information embossed. As we all know from our own experience, these labels have survived more than one wash - which is probably the best proof of the durability of this material!



RANGE OF POSSIBILITIES & ZERO WASTE

This lightweight and versatile fabric can be sewn, cut (without tearing) and washed like fabric. However, high temperatures should be avoided to maintain its properties. The fibre-based texture softens and creases with use and washing, becoming more leather-like over time. It is therefore an excellent alternative to animal-based and PU leather. Unused leftovers can be recycled, making Wash Paper a zero waste material.

The strength and decorative properties of Wash Paper offer a wide range of possibilities! It can be used to make bags, home furnishings, office supplies, notebook or books covers. You can dye it, stamp it, embroider it, stitch it with other materials, print it or even type on it. It all depends on your imagination and creativity!



949106



1706106



539106



1027106



1758106



PAPER THAT CAN HANDLE EVERYTHING!

SEE MORE ENVIRONMENTALLY FRIENDLY PRODUCTS FROM WASH PAPER





IMAGE SOURCES

Page 2: Author: Maria Gralewska, CC BY-SA 4.0, https://commons.wikimedia.org/wiki/File:Cech_rzemios%C5%82_r%C3%B3%C5%BCnych_tabliczka.jpg; page 3: Philippe Starck, Author: Jimmy Baikovicus, CC SA 2.0, https://commons.wikimedia.org/wiki/File:Philippe_Starck3.jpg; page3: Lemon squeezer by Starck, Author: Saiko, CC BY 3.0, https://en.m.wikipedia.org/wiki/File:Philippe_starck_per_alessi_spa_spremiagrami_juicy_salif_1990.jpg; page 23: Dieter Rams, Author: Vitsœ, CC BY-SA 3.0, https://commons.wikimedia.org/wiki/File:Designer-Dieter_Rams.jpg; page 23: Radio T3 vs iPod, <https://designwanted.com/dieter-rams-ten-commandments-good-design-applied-today/>; page 26-27: [Retro ladies, Photo by Les Anderson on Unsplash; Costume Parisien, Author: unknown, CC 0 1.0, https://commons.wikimedia.org/wiki/File:Costume_Parisien_Toquet_%C3%A0_Pointes_Robe_de_Madras_K5177.jpg; Reticule - sketch, Author: David Ring, CC 0 1.0, <https://commons.wikimedia.org/wiki/File:Reticule.tif>]; page 31: Radio Frequency, <https://www.rfidfuture.com/pl/lf-hf-and-uhf-frequency-whats-the-difference.html>; page 35: Snowflake, Author: Alexey Kljatov, CC BY 2.0, [https://commons.wikimedia.org/wiki/File:Snowflake_-_Flickr_-_Alexey_Kljatov_\(5\).jpg](https://commons.wikimedia.org/wiki/File:Snowflake_-_Flickr_-_Alexey_Kljatov_(5).jpg); page 38: Auto-stoppeur, Author: Yves Tessier, CC SA 2.0, https://commons.wikimedia.org/wiki/File:Auto-stoppeur_196-2-005.jpg; page 39: FSO Syrena, NAC, Public domain; page 46: Legio XXI Rapax, Roland zh, CC BY-SA 3.0, https://commons.wikimedia.org/wiki/File:Legio_XXI_Rapax_-_Sechsel%C3%A4uten_2011_-_Lindenhof_2011-04-10_15-56-26.jpg; page 47: Budget 2014; Chancellor George Osborne delivering his Budget Statement, Author: HM Treasury, UK Open Government Licence v3.0, https://commons.wikimedia.org/wiki/File:Budget_2014_-_Chancellor_George_Osborne_delivering_his_Budget_Statement.jpg; page 49: Mosquito in amber, Author: Didier Desouens, CC BY-SA 4.0, https://commons.wikimedia.org/wiki/File:Ambre_Dominique_Moustique.jpg; page 51: [Olga Malinkiewicz, Author: Borys Kozielski, CC BY 4.0, altered, https://commons.wikimedia.org/wiki/Category:Olga_Malinkiewicz#/media/File:Olga_Malinkiewicz.jpg; Rectangular perovskite crystal in Petri dish, Author: Ktimliu, CC BY-SA 4.0, https://en.wikipedia.org/wiki/File:Rectangular_perovskite_crystal.jpg#/media/File:Rectangular_perovskite_crystal_in_Petri_dish.jpg]; page 52-53: [Media Matrix, TED 2010, Author: Steve Jurvetson, CC SA 2.0, https://commons.wikimedia.org/wiki/File:Media_Matrix,_TED_2010.jpg; Head of TED Chris Anderson and host of The TED AI Show Bilawal Sidhu speak at Session 2 of TED2024: The Brave and the Brilliant, on Tuesday, April 16, 2024, in Vancouver, BC, Canada. (Photo: Gilberto Tadday / TED), <https://blog.ted.com/mind-expanders-notes-on-session-2-of-ted2024/>]; page 54: Steve Jobs and Bill Gates during an interview by Walter Mossberg and Kara Swisher, Author: Joi Ito, altered, CC-A 2.0 Generic, [https://commons.wikimedia.org/wiki/File:Steve_Jobs_and_Bill_Gates_\(522695099\).jpg](https://commons.wikimedia.org/wiki/File:Steve_Jobs_and_Bill_Gates_(522695099).jpg); page 55: Portrait d'Albert Einstein, Author: Oren Jack Turner, Public domain, https://commons.wikimedia.org/wiki/File:Albert_Einstein_1947.jpg; page 57: Bieguny geograficzne a magnetyczne, IBE Ministerstwo Edukacji i Nauki, <https://zpe.gov.pl/a/jak-dziala-kompas/DITVdtwnf>; page 58: Medieval drolleries, Public domain; page 65: Wim Hof, Author: Aad Villerius, CC SA 2.0, https://commons.wikimedia.org/wiki/File:Wim_Hof.jpg; page 69: [Xmas crowd, 42d St. Fifth Ave., Library of Congress, Washington, DC; <https://www.loc.gov/pictures/item/2014703663/>; A New York Times report from 1975 locates the phrase "Black Friday" as a bit of Philadelphia slang, BBC, <https://www.bbc.com/news/business-25110953>]; page 70: [F.J. Loudin, Patent Key Fastener, Google Patents, <https://patents.google.com/patent/US512308A/en>; F.J. Loudin portrait, The coloured American (Washington, D.C.), December 22, 1900, Library of Congress, Washington, DC; <https://www.loc.gov/resource/sn83027091/1900-12-22/ed-1/?sp=1&r=0.707,-0.141,2.414,1.643,0>]; page 73: Harald Blåtand, kalkmaleri fra 1500-tallet i Roskilde Domkirke, Sjælland, Denmark; Public domain; https://upload.wikimedia.org/wikipedia/commons/0/0f/Harald_Bl%C3%A5stand_%28Roskilde_Domkirke%29.jpg.

WE RESERVE THE RIGHT TO MAKE CHANGES TO THE RANGE OF PRODUCTS, MATERIALS AND SPECIFICATIONS PRESENTED IN THIS CATALOGUE WITHOUT PRIOR NOTICE.



Polska

Project co-financed by Ministry of Economic Development & Technology
Zadanie jest współfinansowane przez Ministra Rozwoju i Technologii

made-catalogue.com